

# User Guide

Vaisala HUMICAP<sup>®</sup> Humidity Module  
**HMM100**

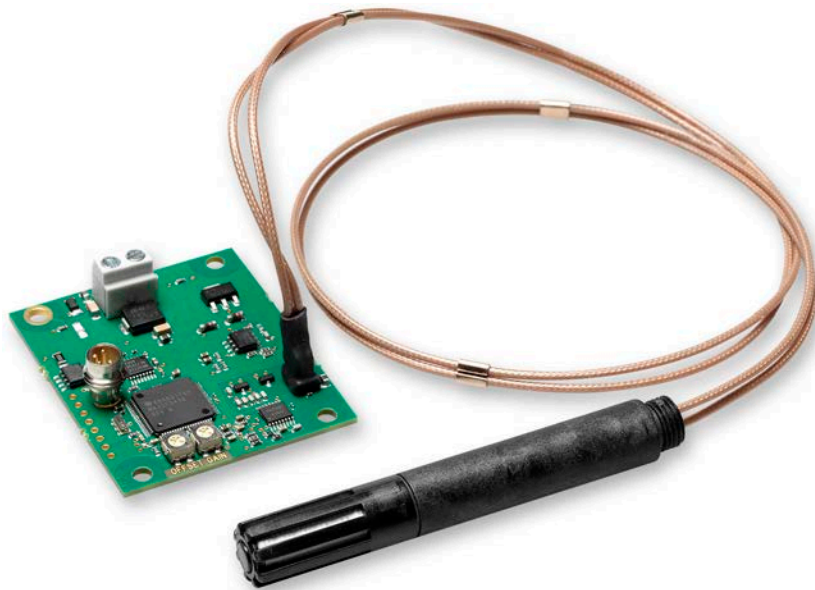

PUBLISHED BY

Vaisala Oyj

Vanha Nurmijärventie 21, FI-01670 Vantaa, Finland

P.O. Box 26, FI-00421 Helsinki, Finland

+358 9 8949 1

Visit our Internet pages at [www.vaisala.com](http://www.vaisala.com).

© Vaisala Oyj 2019

No part of this document may be reproduced, published or publicly displayed in any form or by any means, electronic or mechanical (including photocopying), nor may its contents be modified, translated, adapted, sold or disclosed to a third party without prior written permission of the copyright holder. Translated documents and translated portions of multilingual documents are based on the original English versions. In ambiguous cases, the English versions are applicable, not the translations.

The contents of this document are subject to change without prior notice.

Local rules and regulations may vary and they shall take precedence over the information contained in this document. Vaisala makes no representations on this document's compliance

with the local rules and regulations applicable at any given time, and hereby disclaims any and all responsibilities related thereto.

This document does not create any legally binding obligations for Vaisala towards customers or end users. All legally binding obligations and agreements are included exclusively in the applicable supply contract or the General Conditions of Sale and General Conditions of Service of Vaisala.

This product contains software developed by Vaisala or third parties. Use of the software is governed by license terms and conditions included in the applicable supply contract or, in the absence of separate license terms and conditions, by the General License Conditions of Vaisala Group.

## Table of Contents

<b>1. About This Document</b> .....	5
1.1 Version Information.....	5
1.2 Related Manuals.....	5
1.3 Documentation Conventions.....	5
1.4 Trademarks.....	6
<b>2. Product Overview</b> .....	7
2.1 Introduction to HMM100 Series Humidity Modules.....	7
2.2 Basic Features and Options.....	8
2.3 Probe Types.....	8
2.4 Filter Types.....	9
2.5 Installation Accessories.....	10
2.5.1 Probe Mounting Flange.....	10
2.5.2 Probe Mounting Clamp.....	11
2.5.3 Mounting Bracket with Lid.....	11
2.5.4 Module Housing (IP65).....	12
2.6 Safety.....	12
2.6.1 ESD Protection.....	13
2.7 Regulatory Compliances.....	13
<b>3. Installation</b> .....	15
3.1 Dimensions.....	15
3.2 Installing the Module.....	16
3.3 Installing the Probe.....	16
3.3.1 Mounting HMM100 Probe to Mounting Clamp.....	17
3.4 Wiring.....	19
3.4.1 2-wire Output.....	19
3.4.2 3-wire Output.....	19
3.5 Verifying Installation.....	20
<b>4. Operation</b> .....	21
4.1 Using Service Port.....	21
4.1.1 Installing the Driver for the USB Service Cable.....	21
4.1.2 Terminal Application Settings.....	22
4.2 List of Serial Commands.....	24
4.3 Device Information and Status.....	26
4.3.1 Show Device Information.....	26
4.3.2 Show Quantities.....	26
4.3.3 Show Calibration Info.....	27
4.3.4 Show Analog Output Status.....	27
4.3.5 Show Firmware Version.....	27
4.4 Serial Line Output Commands.....	28
4.4.1 Start Measurement Output.....	28
4.4.2 Stop Measurement Output.....	28
4.4.3 Set Output Interval.....	28
4.4.4 Output a Reading Once.....	29
4.5 Calibration Commands.....	29
4.5.1 Calibrate Temperature Measurement.....	29
4.5.2 Calibrate Humidity Measurement.....	30
4.5.3 View User Adjustment Parameters.....	31
4.5.4 Set User Adjustment Parameters.....	31
4.5.5 Zero the Trimmers.....	32
4.5.6 Calibrate Analog Output.....	33

4.6	Configuring Serial Line Operation.....	33
4.6.1	Set Serial Line Settings.....	33
4.6.2	Set Terminal Echo.....	34
4.6.3	Set Module Address.....	34
4.6.4	Set Serial Interface Mode.....	35
4.7	Configuring Measurement Parameters.....	36
4.7.1	Set Environmental Compensation Values.....	36
4.7.2	Set Temporary Pressure Compensation Value.....	36
4.8	Configuring Analog Output.....	37
4.8.1	Set Analog Output Mode.....	37
4.8.2	Select Analog Output Quantity and Scaling.....	38
4.8.3	Test Analog Output.....	39
4.9	Other Commands.....	39
4.9.1	Display Command List.....	39
4.9.2	Enable Advanced Commands.....	40
4.9.3	Display Currently Active Errors.....	40
4.9.4	Connecting to the Module in POLL Mode.....	40
4.9.5	Closing the Connection in POLL Mode.....	40
4.9.6	Save Changed Settings.....	41
4.9.7	Restore Saved Settings.....	41
4.9.8	Reset the Module.....	41
4.9.9	Restore Factory Settings.....	42
<b>5.</b>	<b>Maintenance.....</b>	<b>43</b>
5.1	Changing Filter.....	43
5.2	Changing Sensor.....	43
5.3	Calibration.....	45
5.4	Calibration and Adjustment Using Trimmers.....	46
5.5	Calibration and Adjustment Using Serial Line.....	47
5.5.1	Temperature Calibration (CT).....	47
5.5.2	Humidity Calibration (CRH).....	50
<b>6.</b>	<b>Troubleshooting.....</b>	<b>53</b>
6.1	Analog Output Error Notification.....	53
6.2	Problems and Their Possible Solutions.....	53
<b>7.</b>	<b>Technical Data.....</b>	<b>55</b>
7.1	Dimensions.....	58
7.2	Accessories.....	58
	<b>Warranty.....</b>	<b>61</b>
	<b>Technical Support.....</b>	<b>61</b>
	<b>Recycling.....</b>	<b>61</b>

## List of Figures

Figure 1	HMM100 Humidity Module with Probe.....	7
Figure 2	Probe Types.....	9
Figure 3	Extended 400-mm Plastic Probe.....	9
Figure 4	Optional Probe Mounting Flange.....	10
Figure 5	HMM100 Probe with Mounting Clamp.....	11
Figure 6	Mounting Bracket with Lid.....	12
Figure 7	Optional Module Housing.....	12
Figure 8	HMM100 Dimensions. Left to Right: Standard and Extended Probe Body.....	15
Figure 9	Component Board (3-wire Version).....	16
Figure 10	Wiring for 2-wire Output.....	19
Figure 11	Wiring for 3-wire Output.....	20
Figure 12	PuTTY Terminal Application.....	24
Figure 13	Changing the Sensor.....	45
Figure 14	Trimmers for Offset and Gain.....	46
Figure 15	Loop Supply Voltage Versus Loop Resistance.....	56
Figure 16	HMM100 Dimensions. Top to Bottom: Standard and Extended Probe Body.....	58

## List of Tables

Table 1	Document Versions (English).....	5
Table 2	Related Manuals.....	5
Table 3	Quantities Measured by HMM100.....	7
Table 4	Filter Types and Properties.....	9
Table 5	HMM100 Default Serial Interface Settings.....	22
Table 6	Basic Serial Commands.....	24
Table 7	Advanced Serial Commands.....	25
Table 8	Error Levels for Analog Output Modes.....	53
Table 9	Measurement Performance.....	55
Table 10	Operating Environment.....	55
Table 11	Inputs and Outputs.....	56
Table 12	HMM100 3-wire Model Current Consumption.....	56
Table 13	Mechanical Specifications.....	57
Table 14	Spare Parts and Accessories.....	58

# 1. About This Document

## 1.1 Version Information

This document provides instructions for installing, operating, and maintaining Vaisala HUMICAP® Humidity Module HMM100.

Table 1 Document Versions (English)

Document Code	Date	Description
M211024EN-E	March 2019	This manual. Revised information on the HUMICAP® R2 sensor. Removed section Patent Notice. Added new cable length (0.6 m) for the stainless steel probe.
M211024EN-D	March 2018	Added information on the following: <ul style="list-style-type: none"> <li>• HUMICAP® R2 and HUMICAP® 180V humidity sensor</li> <li>• Extended 400-mm-long option for the plastic probe</li> <li>• PPS plastic grid with stainless steel net filter option</li> </ul> Removed information on the catalytic VHP filter.
M211024EN-C	November 2013	Removed RHCAL command. Added information on which parameter changes must be saved separately and which are saved automatically.

## 1.2 Related Manuals

Table 2 Related Manuals

Document Code	Name
M210185EN	<i>Vaisala Humidity Calibrator HMK15 User's Guide</i>
M211002EN	<i>Vaisala HUMICAP® Humidity Module HMM100 Quick Reference Guide</i>
M211078EN	<i>Module Housing (IP65) for Humidity Module HMM100 Quick Reference Guide</i>
M211079EN	<i>Mounting Bracket for Humidity Module HMM100 Quick Reference Guide</i>
M211080EN	<i>Mounting Flange for Humidity Probes Quick Reference Guide</i>

## 1.3 Documentation Conventions



**WARNING!** Warning alerts you to a serious hazard. If you do not read and follow instructions carefully at this point, there is a risk of injury or even death.



**CAUTION! Caution** warns you of a potential hazard. If you do not read and follow instructions carefully at this point, the product could be damaged or important data could be lost.



**Note** highlights important information on using the product.



**Tip** gives information for using the product more efficiently.



Lists tools needed to perform the task.



Indicates that you need to take some notes during the task.

## 1.4 Trademarks

Vaisala® and HUMICAP® are registered trademarks of Vaisala Oyj.

Windows® is either a registered trademark or trademark of Microsoft Corporation in the United States and other countries.

All other product or company names that may be mentioned in this publication are trade names, trademarks, or registered trademarks of their respective owners.



## 2. Product Overview

### 2.1 Introduction to HMM100 Series Humidity Modules

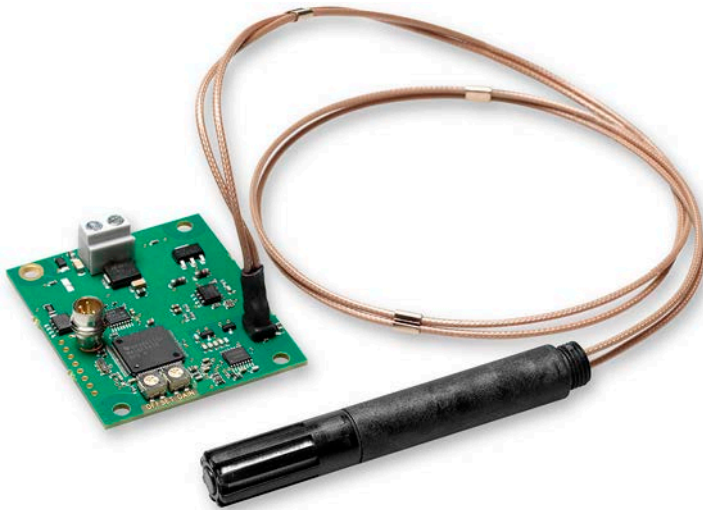

Figure 1 HMM100 Humidity Module with Probe

The HMM100 series humidity measurement modules are open frame modules intended for integration into environmental chambers and other chambers where high temperature tolerance is important. The modules provide a single analog output channel for relative humidity (RH) or dewpoint ( $T_d$ ). Dewpoint is the recommended quantity if the measurement environment has significant temperature differences.

Table 3 Quantities Measured by HMM100

Quantity	Range
Relative humidity (RH)	0 ... 100 %
Dewpoint ( $T_d$ )	-20 ... +100 °C (-4 ... +212 °F)

All HMM100 modules include automatic temperature compensation across the operating temperature range using an integrated Pt1000 sensor. No external temperature compensation should be applied to the output.

HMM100 modules do not incorporate probe heating or chemical purge functionality. If the measurement environment is prone to condensation, or likely to cause chemical contamination of the sensor, other Vaisala instruments may be more suitable to the application.

The cable and probe of the HMM100 are attached at the factory. They should remain connected to the module at all times; do not cut and re-connect the cable.

## 2.2 Basic Features and Options

- Vaisala HUMICAP 180R humidity sensor
- Plastic or stainless steel probe
  - The plastic probe is available in two sizes, a standard one and an extended 400-mm-long option
- Analog output options:
  - 4 ... 20 mA loop powered (2-wire output model)
  - 0 ... 20 mA or 0 ... 1/5/10 V (3-wire output model, user-configurable using service port)
- Cable lengths:
  - 0.6 m, 1.55 m, or 2.9 m for the standard plastic probe
  - 1.55 m for the extended 400-mm-long plastic probe
  - 0.6 m, 1.55 m, or 2.9 m for the stainless steel probe
- Various filter types
- Optional installation accessories:
  - Probe mounting flange
  - Probe mounting clamp
  - Mounting bracket with lid
  - Module housing (IP65)
- Service port for maintenance
  - Optional USB cable for easy access

### More Information

- [Probe Types \(page 8\)](#)
- [Filter Types \(page 9\)](#)
- [Installation Accessories \(page 10\)](#)
- [Using Service Port \(page 21\)](#)

## 2.3 Probe Types

The HMM100 can be ordered with a plastic or stainless steel probe. The plastic probe is available in two sizes, a standard one and an extended 400-mm-long option. The plastic probe is suitable for most applications.

The standard plastic probe and the steel probe have the same operational temperature range (-70 °C to +180 °C). The extended 400-mm plastic probe is suitable for temperatures ranging from -70 °C to +120 °C. Note that the operational temperature range is also affected by the filter; see [Filter Types \(page 9\)](#).

[Figure 2 \(page 9\)](#) shows the plastic probe with a membrane filter (top), and the stainless steel probe with a sintered stainless steel filter (bottom).



Figure 2 Probe Types





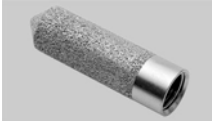

Figure 3 Extended 400-mm Plastic Probe

## 2.4 Filter Types

All filters available for HMM100 are 12 mm in diameter, and can be used in both the plastic and stainless steel probe. Note the operational temperature range of each filter. For order codes, see [Accessories \(page 58\)](#).

Table 4 Filter Types and Properties

	Filter Type	Diameter	Pore Size	Temperature Range
	Plastic grid (fastest response time)	12 mm	-	-20 ... +80 °C (-4 ... +176 °F)
	Membrane	12 mm	0.2 μm	-20 ... +80 °C (-4 ... +176 °F)

	Filter Type	Diameter	Pore Size	Temperature Range
	Porous PTFE (general purpose)	12 mm	8 µm	-70 ... +180 °C (-94 ... +356 °F)
	Stainless steel sintered	12 mm	38 µm	-70 ... +180 °C (-94 ... +356 °F)
	PPS plastic grid with stainless steel net	12 mm	15 µm	-70 ... +180 °C (-94 ... +356 °F)

## 2.5 Installation Accessories

For order codes of installation accessories, see [Accessories \(page 58\)](#).

### 2.5.1 Probe Mounting Flange

The probe mounting flange is used to seal the cable pass-through in the chamber wall. The flange can also be used to hold the probe itself, in case the probe cannot be mounted on the chamber wall otherwise. This mounting is not ideal since leaving the probe cable completely outside the measurement environment may cause heat conduction that affects the measurement. Therefore, installation using mounting flange is recommended for the 400-mm-long probe option only, as the risk of heat conduction to the sensor is smaller than with the shorter, standard-length probe.



Figure 4 Optional Probe Mounting Flange

## 2.5.2 Probe Mounting Clamp

The optional mounting clamp makes it easy to install the probe on the wall of the measurement environment. The probe can be detached for calibration simply by loosening the lower screw.

Installing the entire probe in the measurement environment prevents heat conduction to the sensor, and is the recommended installation method.



Figure 5 HMM100 Probe with Mounting Clamp



Use 2 mounting clamps for stability when installing the longer, 400-mm plastic probe.

### More Information

- [Mounting HMM100 Probe to Mounting Clamp \(page 17\)](#)

## 2.5.3 Mounting Bracket with Lid

The optional mounting bracket includes a metal backplate and a plastic lid for the component board. The bracket does not provide IP rated protection. The bracket can be installed on a DIN rail.



Figure 6 Mounting Bracket with Lid

### 2.5.4 Module Housing (IP65)

The optional module housing is an IP65 rated housing. The module is installed inside the housing in a mounting bracket (provided with the housing). The housing has two cable glands. A coaxial plug is provided for sealing the gland for the probe cable.



Figure 7 Optional Module Housing

## 2.6 Safety

The module delivered to you has been tested for safety and approved as shipped from the factory. Note the following precautions:



**WARNING!** Ground the product and verify installation grounding periodically to minimize shock hazard.



**CAUTION!** Do not modify the unit or use it in ways not described in the documentation. Improper modification may lead to safety hazards, equipment damage, failure to perform according to specification, or decreased equipment lifetime.

## 2.6.1 ESD Protection

Electrostatic Discharge (ESD) can cause immediate or latent damage to electronic circuits. Vaisala products are adequately protected against ESD for their intended use. However, it is possible to damage the product by delivering an electrostatic discharge when touching, removing or inserting any objects inside the equipment housing.

Avoid touching component contacts or connectors when working with the device.

## 2.7 Regulatory Compliances

The HMM100 is in conformity with the provisions of the following EU directive(s):

- RoHS Directive
- WEEE Directive

The electromagnetic compatibility of the HMM100 has been tested according to the following product family standard:

EN61326-1 Electrical equipment for measurement, control and laboratory use - EMC requirements - for use in light industrial environments.

The Electrostatic Discharge test (EN 61000-4-2) was not applied to the open frame module. In the final product the module PC-board should be installed in a user restricted location / enclosure for continued ESD protection.







# 3. Installation

## 3.1 Dimensions

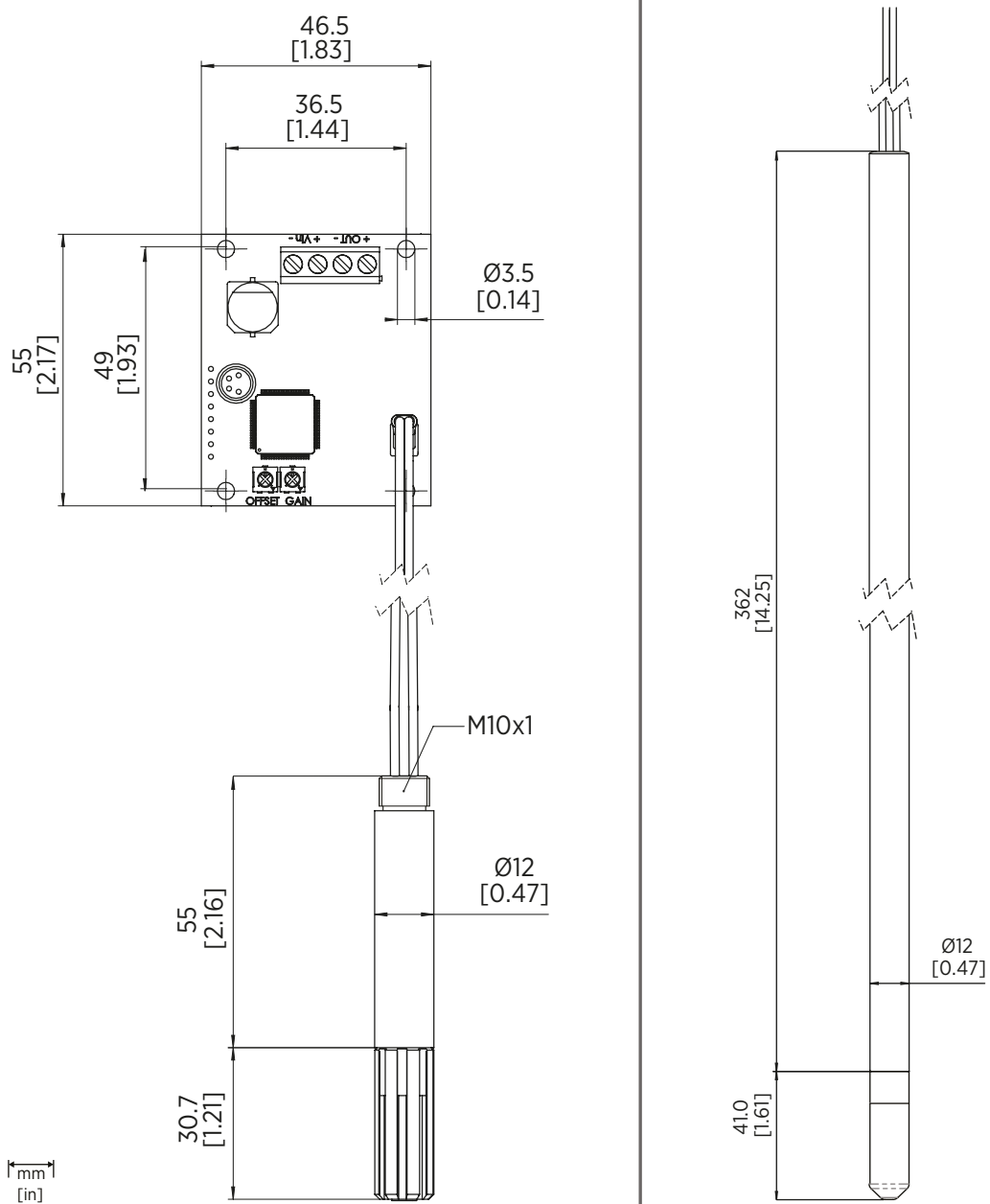

Figure 8 HMM100 Dimensions. Left to Right: Standard and Extended Probe Body

## 3.2 Installing the Module



The measurement probe with cable is attached to the component board at Vaisala. Do not disconnect and reconnect the cable.

- ▶ 1. Attach the module securely using the mounting holes on the corners of the component board. Use the optional mounting bracket (Vaisala order code 225979) if needed.
2. Make sure that the module has a good earth connection from the plated mounting hole.



The installation holes on the component board are compatible with Vaisala HMM22 and HMM30 humidity modules. Remember to disable temperature compensation (if any) in the measurement system when replacing an old module with the HMM100. The temperature compensation in the HMM100 is always enabled.

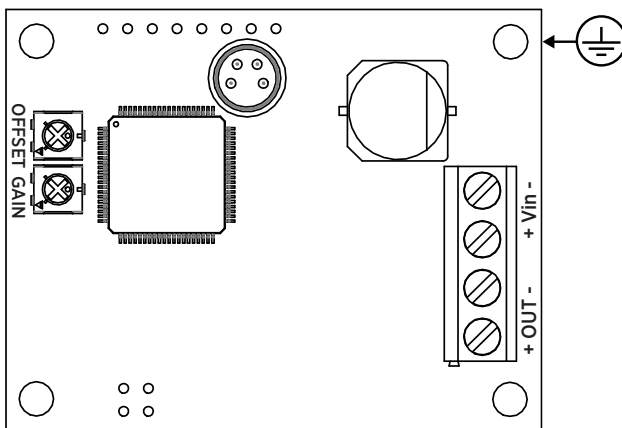

Figure 9 Component Board (3-wire Version)

## 3.3 Installing the Probe

- ▶ 1. Select the mounting location for the probe.
  - The probe should be entirely in the measurement environment, with sufficient distance to the outer walls of the chamber or duct. Air should flow freely around the probe.
  - The probe location should represent well the environmental or process conditions, and it should be as clean as possible.

2. Install the probe in the location. Use the probe mounting clamp (Vaisala order code 226067) if needed. See [Mounting HMM100 Probe to Mounting Clamp \(page 17\)](#).
  - Insert enough cable to the same space with the probe in order to prevent heat conduction, and to make it easy to move the probe when performing a calibration.
  - If you cannot install the probe entirely in the measurement environment, you can use the probe mounting flange (Vaisala order code 226061) to mount the probe through the chamber wall. This installation method is recommended for the 400-mm-long probe option only, as the risk of heat conduction to the sensor is smaller than with the shorter, standard-length probe.
3. Seal the cable pass-through using the probe mounting flange or silicone sealant.



If you seal the cable pass-through using silicone sealant, do not use a sealant that releases acetic acid when curing. Acetic acid may damage the HUMICAP sensor in the probe.

### 3.3.1 Mounting HMM100 Probe to Mounting Clamp



Use 2 mounting clamps for stability when installing the longer, 400-mm plastic probe.

- ▶ 1. Align the slots on the clamp parts.



2. Slide the lower clamp part over to the bottom end of the upper part.



3. Place the clamp to the intended location and secure the upper clamp part with a screw.

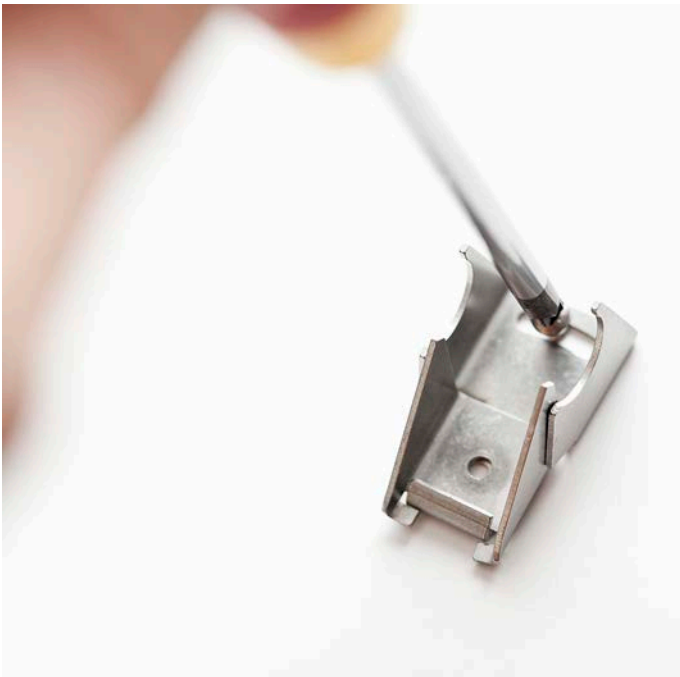

4. Place the probe in the clamp.

5. Tighten the lower clamp part with a screw.



## 3.4 Wiring

### 3.4.1 2-wire Output

Provide a 24 VDC supply voltage. See also [Figure 15 \(page 56\)](#).

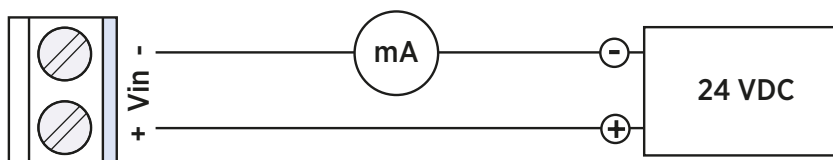

Figure 10 Wiring for 2-wire Output

### 3.4.2 3-wire Output

Provide the required supply voltage according to the output type:

- 10 ... 35 VDC or 24 VAC  $\pm 20\%$  for 0 ... 20 mA, 1/5 V output
- 15 ... 35 VDC or 24 VAC  $\pm 20\%$  for 0 ... 10 V output

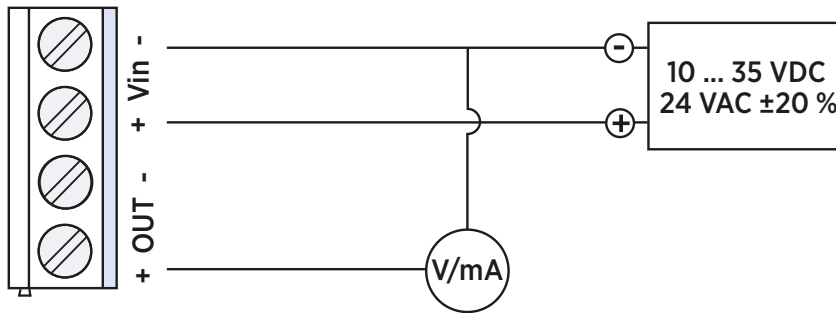

Figure 11 Wiring for 3-wire Output

When using the 3-wire output module, you may also connect a fourth wire to the **Out** terminal. It is internally connected to the **Vin** terminal. This connection is recommended when using the 0 ... 1 V output.

## 3.5 Verifying Installation

- ▶ 1. Power up the module and check the output reading, preferably using a humidity reference.
2. (Optional:) Connect to the service port and use the **ATEST** command to set the analog output to desired voltage or current. Verify that your measurement system shows the correct reading. See [Test Analog Output \(page 39\)](#).  
Note that **ATEST** is one of the advanced serial commands that must be activated using the **PASS** command.

# 4. Operation

## 4.1 Using Service Port

The HMM100 has an RS-232 interface on the component board for service use. You can connect to it through the 4-pin M8 service port connector on the module. Vaisala offers an optional USB cable (Vaisala order code 226068) for connecting the module to your PC.



The service port is intended for short-term use such as calibration. For permanent installation, use the analog output.

The cable does not provide operation power to the module; you must power it normally through the screw terminals.

If you have not used the HMM100 USB cable before, install first the driver that came with the cable.

### 4.1.1 Installing the Driver for the USB Service Cable



Only Windows® operating systems are supported by the driver of the USB service cable.

- ▶ 1. Connect the USB service cable to a USB port on your computer. Windows® detects the new device and installs the appropriate driver.
- 2. Open **Devices and Printers** from the Windows® Start menu. Use search to find it if necessary (search for "devices").

3. Locate the cable in the list of devices:
  - If the device is listed as **Vaisala USB Device** with a COM port number in brackets, the cable is ready for use. **Note the COM port number, you will need it later.**
  - If the device is listed as **Vaisala USB Instrument Cable** without a COM port number listed, you must install the driver manually.

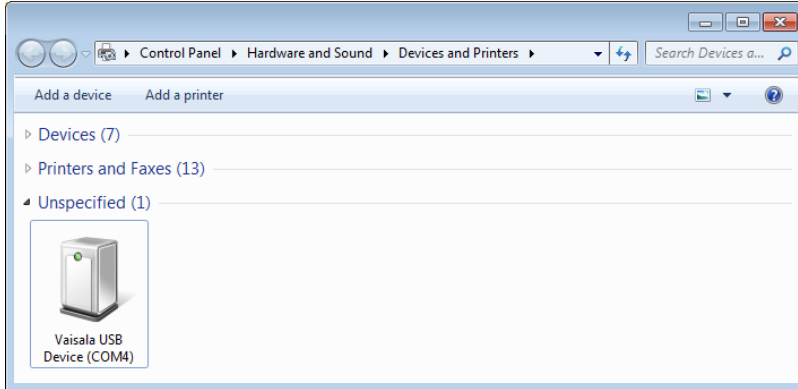

4. To install the driver manually:
  - a. Disconnect the USB service cable from the computer.
  - b. Download the Vaisala USB driver at <http://www.vaisala.com/software> (select the appropriate USB Instrument Driver Setup for your cable).
  - c. Run the USB driver installation program *Vaisala USB Device Driver Setup.exe*. Accept the installation defaults.
  - d. Go back to [step 1](#) and verify that the driver installation works as expected.

## 4.1.2 Terminal Application Settings

Table 5 HMM100 Default Serial Interface Settings

Property	Description / Value
Baud rate	19200
Parity	None
Data bits	8
Stop bits	1
Flow control	None

### 4.1.2.1 Connecting HMM100

The following steps describe how to connect to the HMM100 using the PuTTY terminal application for Windows (available for download at [www.vaisala.com](http://www.vaisala.com)) and a USB serial interface cable:

- ▶ 1. Connect the USB cable between your PC and the service port of the HMM100.
2. Start the PuTTY application.



3. Select the **Serial** settings category, and check that the correct COM port is selected in the **Serial line to connect to** field.



You can check which port the USB cable is using with the **Vaisala USB Instrument Finder program** that has been installed in the Windows **Start** menu.

4. Check that the other serial settings are correct for your connection, and change if necessary. **Flow control** should be set to **None** unless you have a reason to change it.
5. Click the **Open** button to open the connection window and start using the serial line.



If PuTTY is unable to open the serial port you selected, it will show you an error message instead. If this happens, restart PuTTY and check the settings.

6. You may need to adjust the **Local echo** setting in the **Terminal** category to see what you are typing on the serial line. To access the configuration screen while a session is running, click the right mouse button over the session window, and select **Change Settings...** from the pop-up menu.

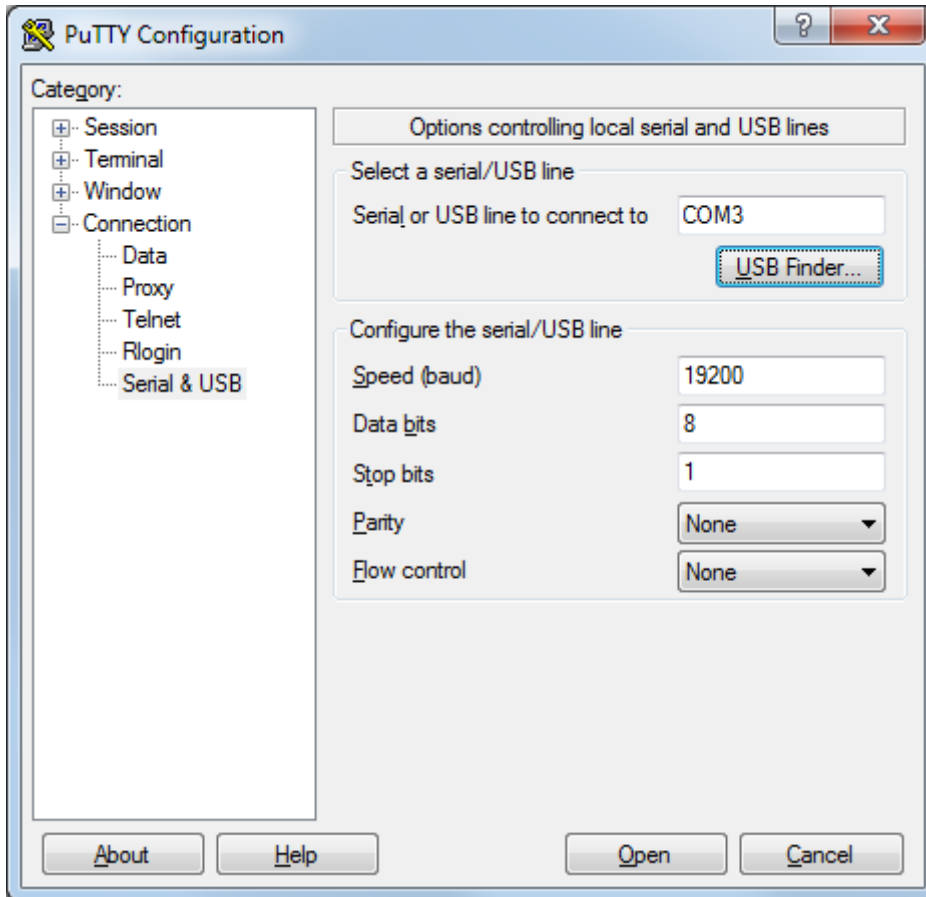

Figure 12 PuTTY Terminal Application

## 4.2 List of Serial Commands

All commands can be issued either in uppercase or lowercase.

The notation <cr> refers to pressing the carriage return (ENTER) key on your computer keyboard. Enter a <cr> to clear the command buffer before starting to enter commands.

Table 6 Basic Serial Commands

Command	Description
?	Show module information
??	Show module information (when in poll mode)
ADDR [0 ... 99]	Set the module address (for POLL mode)

Command	Description
CALCS	Show measured quantities
CLOSE	Close the temporary connection (returns to POLL mode)
ECHO [ON/OFF]	Set terminal echo
ENV	Set environmental parameters
ERRS	Display active errors
HELP	List available commands
INTV [0 ... 255 S/MIN/H]	Set the continuous output interval (for RUN mode)
OPEN [0 ... 99]	Open a temporary connection to a POLL mode device
PASS [passcode]	Access advanced commands (requires passcode)
R	Start the continuous outputting
RESET	Resets the module
RESTORE	Restores the latest saved settings (overwrites unsaved settings)
S	Stop the continuous outputting
SAVE	Save changed settings to memory
SEND [0 ... 99]	Output the reading once
SERI [baud p d s]	User Port settings (Default: 19200 N 8 1) baud: 300 ... 115200
STATUS	Show analog output status
SYSTEM	Show module information and build date
VERS	Show software version of the module
XPRES	Set the value for pressure compensations, temporarily

Table 7 Advanced Serial Commands

Command	Description
ACAL	Calibrate analog output
AMODE	Set/show analog output mode
ASEL [RH/TD]	Set/show analog output quantities and scaling
ATEST	Test analog output; forces the output to the given value
CALINFO	Set/show calibration info
CRH	Calibrate humidity measurement after
CT	Calibrate temperature measurement
FRESTORE	Restore all module settings to factory defaults
L	Show user adjustment parameters
LI	Set user adjustment parameters

Command	Description
SMODE [ <b>STOP</b> /RUN/POLL]	Set the serial interface mode
ZERO	Set correction by trimmers to zero

## 4.3 Device Information and Status

### 4.3.1 Show Device Information

**?<cr>**

The **?** command outputs a listing of device information.

Example:

```
>?
Device Name      : HMM100
SW Name         : HM100
SW model        : VAISALA
SW version      : 1.1.10.3031
Serial number    :
Calibrated      :
Address         : 0
Operating mode  : 3W
Status          : ON
>
```

If the module is in poll mode, but a connection has not been opened using the **OPEN** command, issue the **??** command.

**??<cr>**

For a description of the serial interface modes, see [Set Serial Interface Mode \(page 35\)](#).

### 4.3.2 Show Quantities

**CALCS<cr>**

The **CALCS** command shows the abbreviations of the quantities measured by HMM100.

Example:

```
>calcs
RH Td T
>
```

### 4.3.3 Show Calibration Info

**CALINFO** ["location"]

Use the **CALINFO** command to show or set the calibration info field.

Examples:

```
>calinfo
Calibration location: "VAISALA HELSINKI"
>

>calinfo "Calibration lab 2"
Calibration location: "Calibration lab 2"
>
```

### 4.3.4 Show Analog Output Status

**STATUS** [notification] [level]<cr>

**notification** If specified, enables or disables the analog output error notification. Allowed values ON and OFF.

**level** Error notification level. Allowed values are 0 ... 30.

The **STATUS** command shows the following information:

- Current analog output state (ON for normal, ERROR if an error is active)
- Status of analog channel error notification (ON for enabled, OFF for disabled). See [Analog Output Error Notification \(page 53\)](#).
- Scaling of the selected output quantity (low and high values)
- Error notification level for the current analog output mode

Example (analog output in error state, output quantity RH, analog output mode 0 ... 10V):

```
>status
Channel 0:
Status           : ERROR
Notification     : ON
Level Lo        : 0
Level Hi        : 100
Error level     : 0.000000
```

### 4.3.5 Show Firmware Version

**VERS**<cr>

Example:

```
>vers
HMM100 / HM100 / VAISALA / 1.1.10.3031
>
```

## 4.4 Serial Line Output Commands

### 4.4.1 Start Measurement Output

**R**<cr>

Use the **R** command to start the continuous outputting of measurement values as an ASCII text string to the serial line. The output always includes the readings of the currently selected analog output quantity (RH or Td) and temperature. The format is fixed.

Example:

```
>r
RH= 25.10% T= 24.77' C
RH= 25.12% T= 24.96' C
RH= 25.17% T= 25.20' C
...
```

Outputting the results continues in intervals issued with the command **INTV**. You can stop the output by entering the **S** command.

### 4.4.2 Stop Measurement Output

**S**<cr>

Use the **S** command to stop the continuous measurement output.

### 4.4.3 Set Output Interval

**INTV** [n xxx]<cr>

**n** Time interval in range 1 ... 255

**xxx** time unit = "S", "MIN", or "H"

Use the **INTV** command to show or set the output interval of the serial line measurement messages (applies when the **R** command or RUN mode is used). The shortest output interval is one second. This command has no effect on the operation of the analog output.



Remember to save the changes!

Example:

```
>intv 1 s
Value           : 1
Unit            : S
>save
Saving settings...done
>
```

#### 4.4.4 Output a Reading Once

**SEND** [aa]<cr>

**aa** Module address (0 ... 99). Must be specified if the module is in POLL mode, and a line has not been opened using the **OPEN** command.

Use the **SEND** command to output a single measurement reading from the module.

Example:

```
>send
RH= 25.12 % T= 24.91 'C
>
```

## 4.5 Calibration Commands

Commands that have to do with calibration on the serial line are described below.

For the calibration procedures, see [Calibration \(page 45\)](#).

### 4.5.1 Calibrate Temperature Measurement

**CT**<cr>

Use the **CT** command to perform a one-point or two-point temperature (T) calibration.

When performing a one-point calibration, you need to place the probe in a single temperature reference. Run the command and enter the exact temperature of the reference after the measurement has stabilized. Exit the command by pressing the ESC key before proceeding to the second point (see example 1). To update the value, press ENTER without inputting a value.

For two-point calibration, the second reference point must be at least 20 °C warmer than the first. The measurement reading for the second point will appear when this requirement is met.



Remember to save the changes!

Example (one-point calibration):

```
>ct
T 21.9827 Ref1 ? 22
Press any key when ready
OK
>save
Saving settings...done
>
```

Example (two-point calibration):

```
>ct
T 22.0007 Ref1 ? 22
Press any key when ready ...
T 44.9847 Ref2 ? 45
OK
>save
Saving settings...done
>
```

## 4.5.2 Calibrate Humidity Measurement

### CRH<cr>

Use the **CRH** command to perform a one-point or two-point correction to the humidity measurement of the module. This command changes the offset and gain of the measured capacitance, and therefore affects humidity measurement over the entire temperature range. Take care when making this adjustment, and ensure you make a note of the existing values before adjusting them.

When performing a one-point calibration, you need to place the probe in a single humidity reference with RH < 50 %. Run the command and enter the exact RH of the reference after the measurement has stabilized. Exit the command by pressing the ESC key before proceeding to the second point (see the first example below).

For two-point calibration, the first point requires a RH < 50 % humidity reference, the second point must be RH > 50 %. There must also be at least 30 percentage points of difference between the references.



Remember to save the changes!

Example (one-point calibration):



```

>crh
RH:      11.29915720 Ref1 ? 11.3
Press any key when ready
>save
Saving settings...done
>

```

Example (two-point calibration):

```

>crh
RH:      11.29915720 Ref1 ? 11.3
Press any key when ready
RH:      75.04306440 Ref2 ? 75
OK
>save
Saving settings...done
>

```

### 4.5.3 View User Adjustment Parameters

**L**<cr>

Use the **L** command to view the current user adjustment parameters and trimmer adjustment. This command is useful for checking the currently applied correction.

The output values are as follows:

- Cp offset and gain: capacitance, calibrated using the **CRH** command
- RH trimmer offset and gain: correction by the trimmers
- RH offset and gain: calibrated using the **CRH** command
- T offset and gain: calibrated using the **CT** command

Example (shows default values, no user calibration done):

```

>l
Cp offset          : 0
Cp gain            : 1
RH offset trimmer  : 0
RH gain trimmer    : 1
RH offset          : 0
RH gain            : 1
T offset           : 0
T gain             : 1
>

```

### 4.5.4 Set User Adjustment Parameters

**LI**<cr>

Use the **LI** command to set the user adjustment parameters directly. This command is useful for restoring the desired adjustments, and removing the effects of calibration without having to perform the factory reset.

After entering the command, you will be prompted to enter new values one at a time. Press ENTER without giving a value to move to the next parameter.



Remember to save the changes!

Example (shows default values):

```
>li
Cp offset      : 0 ?
Cp gain        : 1 ?
RH offset      : 0 ?
RH gain        : 1 ?
T offset       : 0 ?
T gain         : 1 ?
>save
Saving settings...done
>
```

## 4.5.5 Zero the Trimmers

**ZERO**<cr>

After physically turning the trimmers to zero, use the **ZERO** command to set the correction by trimmers to exactly zero. It is easy to introduce a small, unwanted correction even if trying to zero the trimmers exactly. This command eliminates the unwanted correction.



Remember to save the changes!

Example:

```
>zero
Trimmer positions set to zero.
>save
Saving settings...done
>
```

## 4.5.6 Calibrate Analog Output

### **ACAL**<cr>

Use the **ACAL** command to calibrate the currently active analog output mode. You must use this command if you change the analog output mode using the **AMODE** command.

After you give this command, the analog output of the module is set to the low limit of the selected output (voltage or current). Measure the output and enter the measured value. After entering the low limit, you must measure and enter the high limit also.

Example (analog output in 4 ... 20 mA mode):

```
>acal
I1 (mA) ? 3.981
I2 (mA) ? 20.002
  2.00985160E+03 a0
  1.12789450E+03 a1
  0.00000000E+00 a2
OK
>save
Saving settings...done
>
```

Example (analog output in 0 ... 1 V mode):

```
>acal
V1 (V) ? 0
V2 (V) ? 0.998
  5.45999950E+02 a0
  1.64128260E+03 a1
  0.00000000E+00 a2
OK
>save
Saving settings...done
>
```

## 4.6 Configuring Serial Line Operation

### 4.6.1 Set Serial Line Settings

#### **SERI** [*b p d s*]<cr>

- B** baud rate (9600, 19200, 38400, 76800, 115200)
- P** parity (n = none, e = even, o = odd)
- D** data bits (7 or 8)
- S** stop bits (1 or 2)

Use the **SERI** command to show or set the serial line settings. Use the **SAVE** command after changing the settings to store them. The new settings will be taken into use when the module is reset or powered up.

Examples:

```
>seri
Baud P D S      : 19200 N 8 1
>

>seri 9600 e 7 1
Baud rate       : 9600
Parity          : E
Data bits       : 7
Stop bits       : 1
>save
Saving settings...done
>
```

## 4.6.2 Set Terminal Echo

**ECHO** [ON/OFF]<cr>

Use the **ECHO** command to show or set the terminal echo status.



Remember to save the changes!

Examples:

```
>echo
Echo           : ON ?
>

>echo on
Echo           : ON
>save
Saving settings...done
>
```

## 4.6.3 Set Module Address

**ADDR** [nn]<cr>

**nn** address (0 ... 99)

To operate in the POLL mode, the module must have an address. If multiple modules share the same serial line, each module must have a different address.

For a description of the serial interface modes, see [Set Serial Interface Mode \(page 35\)](#).



Remember to save the changes!

Example:

```
>addr 1
Address      :      1
>save
Saving settings...done
>
```

#### 4.6.4 Set Serial Interface Mode

**SMODE** [xxx] <cr>

xxx STOP, RUN, or POLL

- In STOP mode: outputting only when command is issued, any command can be used.
- In RUN mode: outputting automatically, only command **S** can be used.
- In POLL mode: outputting only when command is issued, any command can be used after the line has been opened using the **OPEN** command.

Use the **SMODE** command to show or set the serial interface mode. Note that a separate **SAVE** command is not needed to store the new serial interface mode setting.

The polling mode can be used when more than one module is connected to one serial bus. When set to POLL state, the modules communicate one at a time when the specific module address is called on the serial line. See descriptions of the commands **ADDR** ([Set Module Address \(page 34\)](#)) and **OPEN** ([Connecting to the Module in POLL Mode \(page 40\)](#)).

Examples:

```
>smode stop
Output mode  : STOP
>

>smode run
Output mode  : RUN
>

>smode poll
Output mode  : POLL
>
```

## 4.7 Configuring Measurement Parameters

### 4.7.1 Set Environmental Compensation Values

**ENV** [x.xxxx]<cr>

**x.xxxx** Absolute pressure in the measuring environment. The default is **1.013**. The pressure unit is bar.

Use the **ENV** command to show or set the environmental compensation values. In HMM100, the humidity measurement can be compensated for ambient pressure. The value set using **ENV** command is a permanent value which will survive a restart. Use the command **XPRES** instead if the value is changed frequently; see [Set Temporary Pressure Compensation Value \(page 36\)](#).



Remember to save the changes!

Example:

```
>env
Pressure (bar) : 1.013
>

>env 0.980
Pressure (bar) : 0.98
>save
Saving settings...done
>
```



You can use the Vaisala Humidity Calculator to simulate the effect of pressure change to dewpoint. The Humidity Calculator can be found at: [www.vaisala.com/humiditycalculator](http://www.vaisala.com/humiditycalculator)

### 4.7.2 Set Temporary Pressure Compensation Value

**XPRES** [x.xxxx]<cr>

**x.xxxx** Absolute pressure in the measuring environment. The pressure unit is bar.

Use the **XPRES** command to show or set the temporary ambient pressure value for pressure compensation. This value is cleared to 0.0 at reset.

Example:

```
>xpres
Pressure (bar)      : 0
>
```

```
>xpres 1.029
Pressure (bar) : 1.029
>
```

## 4.8 Configuring Analog Output

### 4.8.1 Set Analog Output Mode

**AMODE** [mode] <cr>

**mode** Analog output mode.

Use the **AMODE** command to show or set the operation mode of the analog output. This command is only needed with the 3-wire output module, as the output on the 2-wire model is always 4 ... 20 mA (loop powered).



If you change the analog output mode, you must calibrate the new mode using the **ACAL** command. See [Calibrate Analog Output \(page 33\)](#).

Modes for 3-wire output model:

- 0..1V
- 0..5V
- 0..10V
- 0..20mA
- 4..20mA

Modes for 2-wire output model:

- 4..20mA



Remember to save the changes!

Example (show current mode):

```
>amode
Ch1 : 0..10V
>save
Saving settings...done
>
```

Example (set mode to 0..20 mA):

```
>amode 0..20ma
Ch1 : 0..20MA
>save
Saving settings...done
>
```

## 4.8.2 Select Analog Output Quantity and Scaling

**ASEL** [xx] [low high]<cr>

**xx** Analog channel output quantity

**low** Low limit of scaling

**high** High limit of scaling

Use the **ASEL** command to show or select the quantity output by the analog channels, and the scaling that is used. If you do not enter scaling limits, default values are used.



Remember to save the changes!

Examples:

```
>asel
Quantity          : RH
Level Lo          : 0
Level Hi          : 100
>save
Saving settings...done
>
```



```

>asel td
Quantity          : TD
Level Lo          : -40
Level Hi          : 60
>save
Saving settings...done
>

```

```

>asel td -10 60
Quantity          : TD
Level Lo          : -10
Level Hi          : 60
>save
Saving settings...done
>

```

### 4.8.3 Test Analog Output

**ATEST** [xxx]<cr>

xxx Analog channel output value (V or mA)

Use the **ATEST** command to test the analog output. The **ATEST** command will force the output to the given value, which can then be measured with a calibrated multimeter. The command uses the currently selected analog output mode (voltage or current), so you do not have to specify the unit.

Before testing, check the currently set analog output mode using the **ATEST** command. After testing the output, give the **ATEST** command again to exit the test mode.

Example:

```

>atest 2.5
2.500000, 587f
>

>atest
>

```

## 4.9 Other Commands

### 4.9.1 Display Command List

**HELP**<cr>

Use the **HELP** command to display a list of the currently available commands. If the **PASS** command has not been used, only the basic commands are available.

### 4.9.2 Enable Advanced Commands

**PASS** [passcode]<cr>

**passcode** Use "1300" to enable the advanced commands.

Use the **PASS** command to enable the advanced commands.

Example:

```
>pass 1300
>
```

### 4.9.3 Display Currently Active Errors

**ERRS**<cr>

Use the **ERRS** command to display the currently active error codes. For troubleshooting active errors, see [Problems and Their Possible Solutions \(page 53\)](#).

Example (no active errors):

```
>errs
No errors.
>
```

### 4.9.4 Connecting to the Module in POLL Mode

**OPEN** [aa]<cr>

**aa** address (0 ... 99)

Use the **OPEN** command to connect to a module that is in POLL mode.

Example:

```
open 1
HMM100: 1 line opened for operator commands
>
```

### 4.9.5 Closing the Connection in POLL Mode

**CLOSE**<cr>

The **CLOSE** command closes the connection to the module.

Example:

```
>close
line closed
>
```

## 4.9.6 Save Changed Settings

**SAVE**<cr>

Use the **SAVE** command to save changed settings to the module memory. Most settings have to be saved or the changes are lost at the next reset or power down.



The **SMODE** command saves the new serial mode immediately; a separate **SAVE** command is not needed.

Example:

```
>save
Saving settings...done
>
```

## 4.9.7 Restore Saved Settings

**RESTORE**<cr>

Use the **RESTORE** command to restore saved settings to the module. All unsaved changes will be lost.

Example:

```
>restore
Restoring default settings...done
>
```

## 4.9.8 Reset the Module

**RESET**<cr>

Use the **RESET** command to reset the module. Upon reset or power-up, the module enters the serial mode that has been set with the **SMODE** command.

Example (module set to serial mode STOP, will output module software version at reset):

```
>reset  
HMM100 / VAISALA / 1.1.10.3031  
>
```

## 4.9.9 Restore Factory Settings

### **FRESTORE**<cr>

Use the **FRESTORE** command to restore the factory settings to the module. All user settings, including the analog output mode and user-performed calibration corrections, will be lost. The module will revert back to the factory calibrated settings.

Example:

```
>frestore  
Restoring factory defaults...done  
>
```

## 5. Maintenance

### 5.1 Changing Filter

The filter on the probe should be replaced when it is damaged or dirty. Do not attempt to clean the filter using compressed air, solvents, or mechanical action. Wiping the filter may block its pores and/or deposit residue on the filter.

- ▶ 1. Turn the filter counter-clockwise to loosen it.
2. Remove the filter from the probe. Be careful not to touch the sensors with the filter. Without the filter in place, the sensors are easily damaged – handle the probe carefully.
3. Check that the O-ring is undamaged and in place.
4. Install a new filter on the probe, and tighten it so it is finger-tight. Make sure the filter sits straight and meets the threads properly.

New filters can be ordered from Vaisala. For available filters, see [Filter Types \(page 9\)](#). For order codes of the filters, see [Accessories \(page 58\)](#).

### 5.2 Changing Sensor

You can replace the HUMICAP sensor in the HMM100 module with another sensor in the HUMICAP family. Compatibility of the replacement sensor depends on the SW version of the HMM100 module:

- With modules running SW version 1.3.0 or later, the sensor can be replaced with either HUMICAP 180R or HUMICAP 180V.
- With HMM100 modules running an older SW version, you can replace the sensor only with the same type of sensor as the original.

To check the SW version of the module, issue the **VERS** serial command. See [Show Firmware Version \(page 27\)](#).

You can identify different sensor types by the code printed on the sensor.

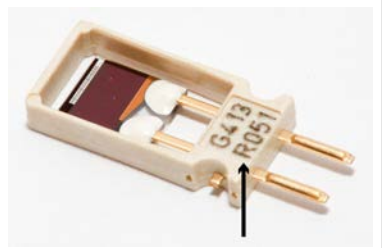
Sensor Type	Identifying Code	Example	Notes
HUMICAP 180R	R		

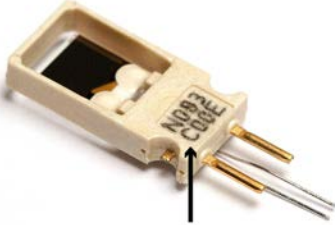
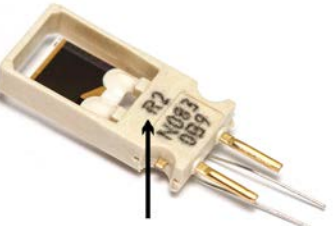
Sensor Type	Identifying Code	Example	Notes
HUMICAP 180V	C		
HUMICAP R2	R2		The HUMICAP R2 sensor (delivered with HMM100 modules in 2018) is no longer available as a replacement option. Use HUMICAP 180R as the replacement sensor for HMM100 modules originally delivered with the HUMICAP R2 sensor.



Replacing the sensor is repair maintenance, and it is not necessary in normal operation. If the accuracy of the module does not seem to be within specification, it is more likely that the module is in need of calibration and adjustment, and not sensor replacement. See [Calibration \(page 45\)](#).

- ▶ 1. Remove the filter from the probe by turning it counter-clockwise.
2. Remove the damaged sensor and insert a new one. Handle the new sensor by the plastic socket. **DO NOT TOUCH THE SENSOR PLATE.**
3. Perform a calibration and adjustment using the **CRH** command as instructed in [Humidity Calibration \(CRH\) \(page 50\)](#).

4. Attach a new filter on the probe. When using the stainless steel filter, take care to tighten the filter properly (recommended force 5 Nm).

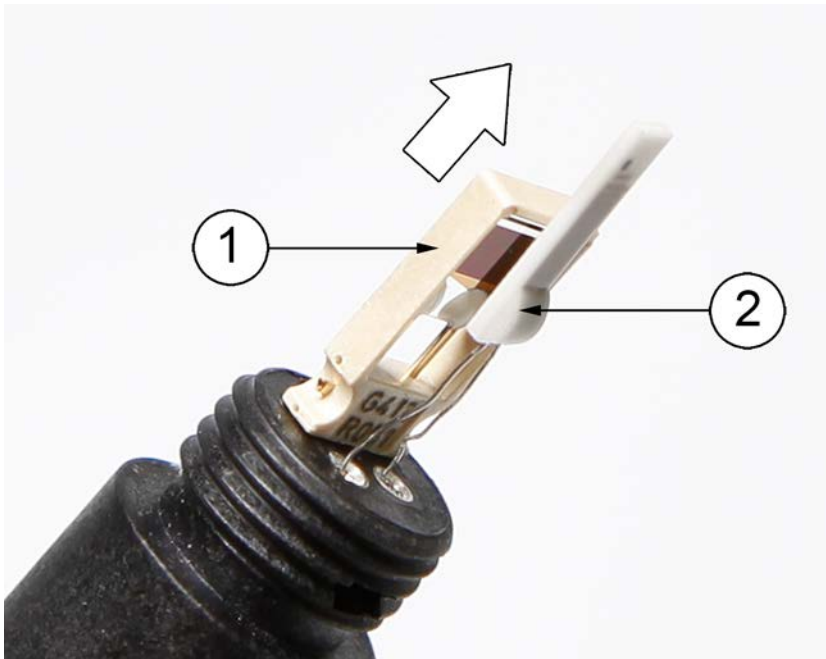

Figure 13 Changing the Sensor

- 1 HUMICAP sensor
- 2 Pt1000 sensor (do not touch)

## 5.3 Calibration

The recommended calibration interval is one year. You should also perform a calibration if the HMM100 does not appear to be within the specified accuracy.

The HMM100 can be adjusted in two ways:

- Using the onboard trimmers. This method requires no serial connection, only a small Phillips head screwdriver and a suitable humidity reference. The trimmers can adjust up to  $\pm 5\%$  of reading.
- Using serial commands. This method requires a connection to the service port of the HMM100 module. For this, you need the USB cable (Vaisala order code 226068) and a PC with a terminal application. You also need a humidity reference and a Phillips head screwdriver for zeroing the trimmers.

As a humidity reference, you can use, for example, the Vaisala Humidity Calibrator HMK15. For more information on the HMK15, see *Vaisala Humidity Calibrator HMK15 User's Guide*.

Installing the probe properly will also help with the calibration. Ideally the probe should be placed completely in the environment, with enough cable to prevent heat conduction, and to allow the probe to be moved during calibration (placed in the HMK15 calibrator, for example).



If you have changed the HUMICAP sensor, center the trimmers, and perform a calibration and adjustment using the serial command **CRH**.



You can only calibrate the humidity measurement (RH) and temperature measurement (T). The module calculates the dewpoint using RH and T values.

## 5.4 Calibration and Adjustment Using Trimmers

HMM100 series modules have two trimmers mounted on the component board. These trimmers allow for easy adjustment of the offset and gain of the humidity measurement.

The modules are shipped with the trimmers centered. Turning the trimmer counter-clockwise will decrease the offset or gain, and turning clockwise will increase it. The adjustment range is  $\pm 5\%$  for both offset and gain.

Offset correction requires a  $< 50\%$  RH reference. Offset and gain correction requires additionally a  $> 50\%$  RH reference, with over  $30\%$  RH difference between the two points.



The trimmers will only turn 135 degrees each way, less than half a rotation. Do not force the trimmer past the stopping point.



Figure 14 Trimmers for Offset and Gain

The procedure below provides an example adjustment of offset and gain using the Vaisala Humidity Calibrator HMK15, which is a saturated salt calibrator. It is assumed that the module is powered and you can measure the analog output reading.





For best results, use the **ACAL** command to calibrate the currently active analog output mode before using the trimmers. For instructions on how to do this, see [Calibrate Analog Output \(page 33\)](#).

- ▶ 1. Note the current position of the trimmers.
2. Insert the probe in the LiCl salt chamber of the humidity calibrator (11 %RH), and wait for 20 – 40 minutes for the reading to stabilize.
3. If necessary, adjust the offset trimmer using a small Phillips head screwdriver to achieve the output reading that corresponds to 11 %RH.
  - For 4 ... 20 mA output, the reading should be 5.76 mA.
  - For 0 ... 5 V output, the reading should be 0.55 V.
4. Insert the probe in the NaCl salt chamber (75 %RH) and wait for the reading to stabilize.
5. If necessary, adjust the gain trimmer to achieve the output reading that corresponds to 75 %RH.
  - For 4 ... 20 mA output, the reading should be 16 mA.
  - For 0 ... 5 V output, the reading should be 3.75 V.
6. Optional: repeat steps 2 – 4 to check the adjustment result. If you want to undo the adjustment, return the trimmers to their original position.

## 5.5 Calibration and Adjustment Using Serial Line

The following chapters provide steps for performing calibrations on the serial line.



It is assumed that the module is powered and you can measure the analog output reading. Note that the USB cable does not supply operation power to the module. You must power it normally through the screw terminals.

### More Information

- ▶ [Using Service Port \(page 21\)](#)
- ▶ [Installing the Driver for the USB Service Cable \(page 21\)](#)
- ▶ [List of Serial Commands \(page 24\)](#)

### 5.5.1 Temperature Calibration (CT)

The following procedure describes a temperature (T) measurement calibration using serial line commands. You can use the procedure to do a one-point calibration (offset) or a two-point calibration (offset and gain). For two-point calibration, the second reference point must be at least 20 °C warmer than the first.

Temperature measurement is not controlled by the trimmers, so do not adjust them during temperature calibration.

1. Connect the USB cable to the service port on the module, and to a USB port on your PC.
2. Start a terminal application and set the correct connection settings. The default serial settings are **19200 8 N 1**. Remember to check which COM port the USB cable is using.
3. Verify that the connection works by giving the **?** command:

```
>?
```

If the module does not respond with device information:

- Check that the module is powered
  - Try the **??** command in case the module is in POLL state, open the line using the **OPEN** command if necessary
  - Check your serial line settings and cable connections
  - Power off the module, unplug the USB cable, restart the terminal application, and try again
4. When your serial connection is working, use the **L** command to see the current user adjustment parameters and the status of the trimmers. Write down the T offset and gain values so you can restore them manually using the **LI** command, if necessary.

```
>l
```

5. Use the **ERRS** command to see that no errors are active:

```
>errs
```

6. Use the **PASS** command to enable the advanced commands:

```
>pass 1300
```

7. Insert the probe in the temperature reference and wait for 20 – 40 minutes for the reading to stabilize.
8. Give the **CT** command. The output from the command shows the currently measured T value, and prompts you to enter the value of the reference 1. This is the reference on the colder end, which produces the offset correction for the measurement.

9. You now have three choices:
  - a. To apply the correction, type the temperature of the reference in degrees Celsius and press ENTER.
  - b. To exit the **CT** command without adjusting the measurement, press the ESC key and exit this procedure.
  - c. To refresh the measured value without typing in the correction, press ENTER.
10. If you only want to perform a one-point calibration (offset correction), press the ESC key after entering the correction. The **CT** command will exit, and you can move to [step 13](#).

```
>ct
T 21.9847 Ref1 ? 22
Press any key when ready
OK
>
```

To continue with the calibration of the warmer end (gain correction), press ENTER.

11. Insert the probe in the second temperature reference and wait for 20 – 40 minutes for the reading to stabilize. The measurement reading for the second point will appear when the measured temperature is at least 20 °C warmer than the first reference point.
12. Type the temperature of the second reference point and press ENTER to apply the correction.

```
T 44.9847 Ref2 ? 45
OK
>
```

The **CT** command is now finished and both adjustments have been applied.

13. Use the **L** command to verify that the new user adjustment parameters are in use:

```
>l
```

14. Use the **SAVE** command to save the changed settings:

```
>save
Saving settings...done
>
```

15. Measure the value of the analog output to verify that the measurement is OK.

## 5.5.2 Humidity Calibration (CRH)

Adjusting the capacitance measurement affects humidity measurement accuracy across the entire temperature range. Take care when making this adjustment.



Be sure to write down the current capacitance adjustment parameters (visible with the **L** command) so that you can restore them manually if necessary.

The following procedure provides a calibration procedure using the serial line commands and the Vaisala Humidity Calibrator HMK15. You can use the procedure to do a one-point calibration (offset) or a two-point calibration (offset and gain).

- One-point calibration requires a < 50 %RH reference
- Two-point calibration requires additionally a > 50 %RH reference, with over 30 %RH difference between the two points.

- ▶ 1. Connect the USB cable to the service port on the module, and to a USB port on your PC.
2. Start a terminal application and set the correct connection settings. The default serial settings are **19200 8 N 1**. Remember to check which COM port the USB cable is using.
3. Verify that the connection works by giving the **?** command:

```
>?
```

If the module does not respond with device information:

- a. Check that the module is powered
  - b. Try the **??** command in case the module is in POLL state, open the line using the **OPEN** command if necessary
  - c. Check your serial line settings and cable connections
  - d. Power off the module, unplug the USB cable, restart the terminal application, and try again
4. When your serial connection is working, use the **L** command to see the current user adjustment parameters and the status of the trimmers. Write down the Cp offset and gain values so you can restore them manually using the **LI** command, if necessary.

```
>l
```

5. Use the **ERRS** command to see that no errors are active:

```
>errs
```

6. Use the **PASS** command to enable the advanced commands:

```
>pass 1300
```

7. Turn both trimmers to zero using the Phillips head screwdriver, and use the **ZERO** command to set their correction to exactly zero:

```
>zero
```

8. Insert the probe in the LiCl salt chamber of the humidity calibrator (11 %RH), and wait for 20 - 40 minutes for the reading to stabilize.
9. Give the **CRH** command. The output from the command shows the currently measured RH value, and prompts you to enter the value of the reference 1. This is the reference on the dry end, which produces the offset correction for the measurement.

```
>crh
RH: 10.971112003 Ref1 ?
```

10. You now have three choices:
- To apply the correction, type 11 and press ENTER (assuming you are using the HMK15 and the LiCl salt)
  - To exit the **CRH** command without adjusting the measurement, press the ESC key and exit this procedure
  - To refresh the measured value without typing in the correction, press ENTER.
11. If you only want to perform a one-point calibration (offset correction), press the ESC key after entering the correction. The **CRH** command will exit, and you can move to [step 14](#).

```
RH: 11.0800360 Ref1 ? 11
Press any key when ready
>
```

To continue with the calibration of the wet end (gain correction), press ENTER.

12. Insert the probe in the NaCl salt chamber (75 %RH) and wait for 20 - 40 minutes for the reading to stabilize.

13. Type 75 and press ENTER to apply the correction (assumes you are using the HMK15 and the NaCl salt).

```
RH: 75.00134550 Ref2 ? 75
OK
>
```

The **CRH** command is now finished and both adjustments have been applied.

14. Use the **L** command to verify that the new user adjustment parameters are in use.

```
>l
```

15. Use the **SAVE** command to save the changed settings.

```
>save
Saving settings...done
>
```

16. Measure the value of the analog output to verify that the measurement is OK.

## 6. Troubleshooting

### 6.1 Analog Output Error Notification

If the module is unable to measure due to an error, the analog output will be set to an error level. The error level depends on the currently selected analog output mode; see the following table.

Table 8 Error Levels for Analog Output Modes

Analog Output Mode	Default Error Level	Maximum Value
0 ... 1 V	0 V	2 V
0 ... 5 V	0 V	6 V
0 ... 10 V	0 V	12 V
0 ... 20 mA	0 mA	30 mA
4 ... 20 mA	3.8 mA	30 mA

You can check the current status of the analog output via the serial interface by using the **STATUS** command. You can also disable this error notification behavior; see [Show Analog Output Status \(page 27\)](#).



If the error state voltage exceeds the normal output range, the minimum required supply voltage is higher. As a rule, add one volt to the supply voltage to get one additional volt from the signal. See [Table 12 \(page 56\)](#). For example, for a 0 ... 5 V output, a 6 V error state needs an 11 V supply voltage.

### 6.2 Problems and Their Possible Solutions

You can check the error message via the serial interface by using the **ERRS** command. In case of constant error, please contact Vaisala technical support.

Problem or Message	Likely Causes and Solutions
Measurement not working, any of the following errors active: <ul style="list-style-type: none"> <li>• Temperature sensor open circuit/not calibrated</li> <li>• Humidity sensor open circuit/not calibrated</li> <li>• Temperature sensor values out of range</li> </ul>	<ul style="list-style-type: none"> <li>• Sensor(s) damaged or missing. Open the filter and check.</li> <li>• Calibration is not done. Calibrate the module.</li> <li>• Check the supply voltage of the module.</li> <li>• Check the analog output mode using the <b>AMODE</b> command.</li> </ul>

Problem or Message	Likely Causes and Solutions
Humidity measurement appears to be wrong. The following errors may be active: <ul style="list-style-type: none"> <li>• RH reading too high</li> <li>• RH reading too low</li> </ul>	<ul style="list-style-type: none"> <li>• Check for condensation on the probe and sensor.</li> <li>• Check that you are not applying temperature compensation in the measurement system (HMM100 has its own).</li> <li>• Check for heat conduction through the cable. Place more cable in the chamber if needed.</li> <li>• Check the position of the trimmers.</li> <li>• Use the <b>L</b> command to check the currently applied calibration correction.</li> <li>• Calibration is not done. Calibrate the module.</li> </ul>
The following error is active: <ul style="list-style-type: none"> <li>• Capacitance out of range</li> </ul>	<ul style="list-style-type: none"> <li>• Sensor broken</li> <li>• Sensor disconnected</li> <li>• Sensor pins twisted and touching</li> <li>• Wrong sensor type inserted</li> <li>• Sensor replaced but capacitance not adjusted. Perform a humidity adjustment using the <b>CRH</b> command.</li> </ul>
Measurement stops, with the following errors active: <ul style="list-style-type: none"> <li>• Analog output test on, no measurements done</li> <li>• MeasTask not calculating (ATEST)</li> </ul>	You are testing the analog output using the <b>ATEST</b> command. This is normal; type <b>ATEST</b> to stop the test and remove this error.
Serial line command not working, outputs "Unknown command."	<ul style="list-style-type: none"> <li>• Mistyped or unknown command</li> <li>• Command not available without using the <b>PASS</b> command first</li> </ul>
Cannot connect to serial line, current serial settings of the module are unknown.	Perform the following steps to connect: <ol style="list-style-type: none"> <li>1. Set your terminal settings to <b>19200 8 N 1</b> (the default settings of the module).</li> <li>2. Connect to the service port of the module.</li> <li>3. Power up the module, and type "z" on the serial line at least five times.</li> <li>4. The module will come online with the default settings, and with the text <b>SERVICE MODE</b>.</li> <li>5. Use the <b>SERI</b> command to set the desired serial settings, and use the <b>SAVE</b> command to save them.</li> </ol>
Any of the following errors is active: <ul style="list-style-type: none"> <li>• Program checksum error</li> <li>• Parameter storage checksum error</li> <li>• Sensor coefficient checksum error</li> <li>• Current settings checksum error</li> <li>• Default settings checksum error</li> <li>• Log corrupted</li> <li>• Resistance measurement</li> </ul>	Internal error. Perform the following steps: <ol style="list-style-type: none"> <li>1. Reset or power cycle the module. Check if the error is gone.</li> <li>2. Return the module to factory settings using the <b>FRESTORE</b> command. Check again.</li> <li>3. If the error is still active, contact Vaisala technical support.</li> </ol>



## 7. Technical Data

Table 9 Measurement Performance

Property	Description/Value
<b>Relative Humidity</b>	
Measurement range	0 ... 100 %RH
Factory calibration uncertainty (+20 °C / +68 °F)	±1.5 %RH
Humidity sensor types	Vaisala HUMICAP® 180R Vaisala HUMICAP® 180V
Accuracy at -20 ... +40 °C (-4 ... +104 °F) (Incl. Non-Linearity, Hysteresis and Repeatability):	
0 ... 90 %RH	±2 %RH
90 ... 100 %RH	±3 %RH
Accuracy at -40 ... -20 °C and +40 ... +180 °C (-40 ... -4 °F and +104 ... +356 °F) (Incl. Non-Linearity, Hysteresis and Repeatability):	
0 ... 90 %RH	±2.5 %RH
90 ... 100 %RH	±3.5 %RH
<b>Dew Point Temperature</b>	
Measurement range	-20 ... +100 °C (-4 ... +212 °F) T <sub>d</sub>
Accuracy (incl. non-linearity, hysteresis and repeatability) when dew point depression <20 °C (+68 °F) (Ambient temperature - dew point)	±2 °C (±3.6 °F) T <sub>d</sub>

Table 10 Operating Environment

Property	Description/Value
EMC compliance	Applicable parts of EN61326-1, Generic Environment
<b>Operating Temperature</b>	
Component board	-5 ... +55 °C (+23 ... +131 °F)
Stainless steel probe	-70 ... +180 °C (-94 ... +356 °F)
Plastic probe (standard body)	-70 ... +180 °C (-94 ... +356 °F)
Plastic probe (extended 400-mm (16-in) body)	-70 ... +120 °C (-94 ... +248 °F)
Plastic grid and membrane filter	-20 ... +80 °C (-4 ... +176 °F)
Porous PTFE, stainless steel sintered, and PPS plastic grid with stainless steel net filter	-70 ... +180 °C (-94 ... +356 °F)

Table 11 Inputs and Outputs

Property	Description/Value
Power consumption	6 mA (typical)
<b>Operating Voltage</b>	
2-wire model 3-wire model	24 VDC 10 ... 35 VDC or 24 VAC ±20 % 15 ... 35 VDC or 24 VAC ±20 % when 0 ... 10 V output is used
<b>Analog Output Types (1 Output Selectable)</b>	
2-wire model 3-wire model	4 ... 20 mA (loop-powered) 0 ... 20 mA, 0 ... 1/5/10 V
Max. wire size	0.5 ... 1.5 mm <sup>2</sup> (AWG)
Service port	M8 connector for USB cable

Table 12 HMM100 3-wire Model Current Consumption

Output DC	Supply Voltage DC	Supply Voltage AC	Load Resistance	Typ. Current Consumption	Max. Current Consumption
0 ... 1 V	10 ... 35 VDC	24 VAC ±20 %	≥ 10 kΩ	6 mA	10 mA
0 ... 5 V	10 ... 35 VDC	24 VAC ±20 %	≥ 10 kΩ	6 mA	10 mA
0 ... 10 V	15 ... 35 VDC	24 VAC ±20 %	≥ 10 kΩ	6 mA	10 mA
0 ... 20 mA	10 ... 35 VDC	24 VAC ±20 %	0 Ω	6 ... 26 mA <sup>1)</sup>	10 ... 30 mA <sup>1)</sup>
0 ... 20 mA	20 ... 35 VDC	24 VAC ±20 %	500 Ω	6 ... 26 mA <sup>1)</sup>	10 ... 30 mA <sup>1)</sup>

1) Current consumption depends on the output current.

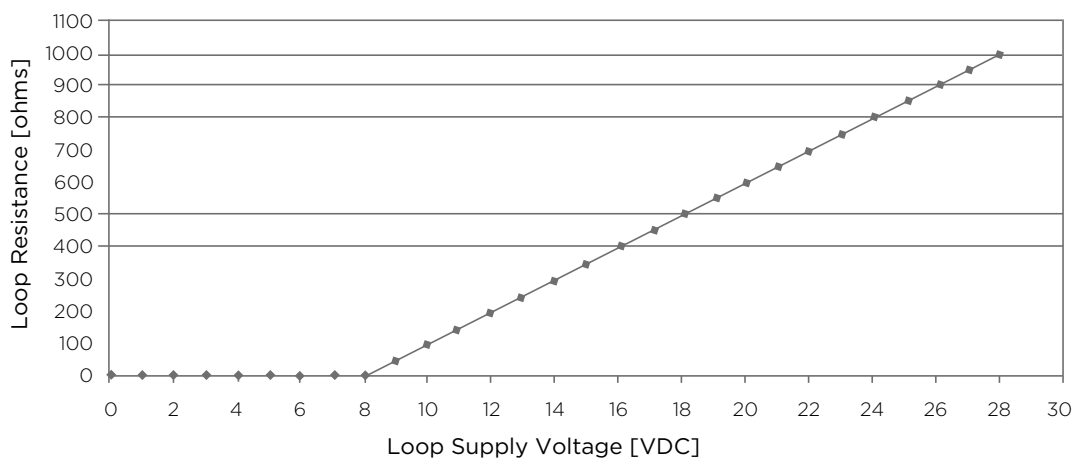

Figure 15 Loop Supply Voltage Versus Loop Resistance

Table 13 Mechanical Specifications

Property	Description/Value
Service cable connector	M8 series 4-pin (male)
Probe diameter	12 mm (0.5 in)
<b>Probe Cable Lengths</b>	
Stainless steel probe	0.6/1.55/2.9 m (2/5.1/9.5 ft)
Plastic probe (standard body)	0.6/1.55/2.9 m (2/5.1/9.5 ft)
Plastic probe (extended 400-mm (16-in) body)	1.55 m (5.1 ft)
<b>Probe Material</b>	
Stainless steel probe	AISI316/PPS
Plastic probe	PPS
Extension tube for 400-mm probe	POM
Probe mounting clamp	AISI316
<b>Mounting Bracket Material</b>	
Lid	ABS/PC
Bottom plate	Al
Module housing material	ABS/PC (cover)

## 7.1 Dimensions

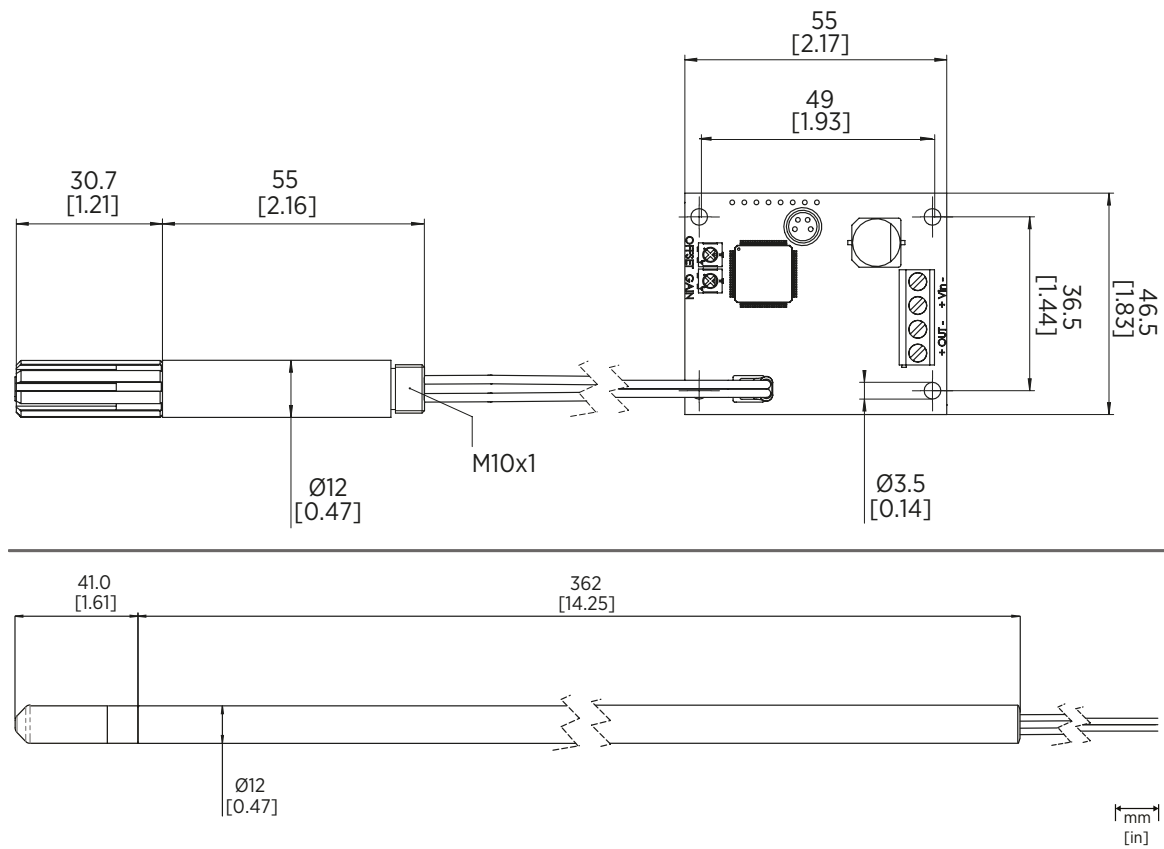

Figure 16 HMM100 Dimensions. Top to Bottom: Standard and Extended Probe Body

## 7.2 Accessories

Table 14 Spare Parts and Accessories

Item	Order Code
Humidity sensor	HUMICAP180R
Humidity sensor	HUMICAP180V
Plastic grid filter	6221
Membrane filter	10159HM
Porous PTFE filter	219452SP
Stainless steel sintered filter	HM47280SP
PPS plastic grid with stainless steel net filter	DRW010281SP
Mounting bracket with lid	225979

Item	Order Code
Module housing (IP65)	226060
Probe mounting flange	226061
Probe mounting clamp set (10 pcs)	226067
USB cable	226068



# Warranty

For standard warranty terms and conditions, see [www.vaisala.com/warranty](http://www.vaisala.com/warranty).

Please observe that any such warranty may not be valid in case of damage due to normal wear and tear, exceptional operating conditions, negligent handling or installation, or unauthorized modifications. Please see the applicable supply contract or Conditions of Sale for details of the warranty for each product.

# Technical Support



Contact Vaisala technical support at [helpdesk@vaisala.com](mailto:helpdesk@vaisala.com). Provide at least the following supporting information:

- Product name, model, and serial number
- Name and location of the installation site
- Name and contact information of a technical person who can provide further information on the problem

For more information, see [www.vaisala.com/support](http://www.vaisala.com/support).

# Recycling



Recycle all applicable material.



Follow the statutory regulations for disposing of the product and packaging.







# VAISALA

[www.vaisala.com](http://www.vaisala.com)

