



# METEOROLOGICAL INSTRUMENTS

## INSTRUCTIONS

**ULTRASONIC ANEMOMETER  
MODEL 86106**



# OPERATING INSTRUCTIONS

Model 86106 Ultrasonic Anemometer

---

## Contents

SECTION	DESCRIPTION	PAGE
1.0	<b>SPECIFICATIONS</b>	1
2.0	<b>INTRODUCTION</b>	1
3.0	<b>BEFORE INSTALLATION</b>	1
4.0	<b>INSTALLATION</b>	2
4.1	Placement	2
4.2	Mounting and Alignment	2
4.3	Wiring Connections	2
5.0	<b>OPERATION</b>	2
5.1	Analog Outputs	2
5.2	With YOUNG Wind Tracker Display	2
5.3	Serial Output Formats and Protocols	2
5.4	Low Power Operation	3
6.0	<b>SETTING SERIAL OUTPUTS AND OPERATING PARAMETERS</b>	
6.1	Setup using YOUNG 86SETUP program	3
6.2	Setup using terminal program	3
6.3	Command Overview	3
6.4	Command Details	4
7.0	<b>EXAMPLE SETTINGS</b>	5
8.0	<b>EMC COMPLIANCE</b>	5
9.0	<b>WARRANTY</b>	5
<b>APPENDIX</b>		
A	<b>WIRING CONNECTIONS</b>	6
B	<b>SENSOR ORIENTATION AND DIMENSIONS</b>	10





## MODEL 86106 ULTRASONIC ANEMOMETER



### 1.0 SPECIFICATIONS

#### WIND SPEED

Range: 0-75 m/s (156 mph)  
 Resolution: 0.01 m/s  
 Accuracy: 0 to 30 m/s  $\pm 2\%$  or 0.1 m/s  
 30 to 75 m/s  $\pm 3\%$

#### WIND DIRECTION

Azimuth Range: 0-360 degrees  
 Resolution: 0.1 degree  
 Accuracy:  $\pm 2$  degrees

#### SERIAL OUTPUT (Selectable)

Interface Type: RS-232 or RS-485/422  
 Formats: ASCII Text (polled and continuous)  
 RMYT (YOUNG Wind Tracker)  
 NMEA  
 Baud Rates: 1200, 4800, 9600, 19200 and 38400

#### ANALOG OUTPUT (Selectable)

Polar Speed: 0-5000mV or 4-20 mA (0 to 100 m/s)  
 Polar Direction: 0-5000mV or 4-20 mA (0 to 360° or 0 to 540°)  
 Cartesian UV: 0-5000mV or 4-20 mA (-100 m/s to +100 m/s)

#### GENERAL

Output rate: 0.1-20 Hz, 1 Hz typical  
 Power Supply: 10 to 30 VDC,  
 20 mA typical, 85 mA max  
 Protection Class: IP65  
 EMC Compliance: FCC Class A digital device  
 IEC standard 61326-1  
 Dimensions: 29 cm high x 11 cm wide  
 Weight: 0.4 kg (0.9 lb)  
 Shipping Weight: 1.6 kg (3.5 lb)  
 Operating Temperature: -40 to +60°C

### 2.0 INTRODUCTION

The YOUNG 86106 Ultrasonic Anemometer is a 2-axis, no-moving-parts wind sensor. It is ideal for general meteorological applications requiring accurate and reliable measurement. The sensor features wide operating range, compact size, easy installation and low power operation.

The 86106 measures wind speed and direction based on the transit time of ultrasonic pulses between three transducers.

Measurement results are available as calibrated analog output signals, or serial data using RS-232 or RS-485. Continuous serial output or polled operation may be used. Serial format options include direct connection to YOUNG Wind Tracker displays, marine NMEA systems, data loggers, or other compatible serial communication devices.

Operating parameters are easily set using the 86SETUP program provided. All 86106 parameter settings are stored internally in non-volatile memory.

The sensor is constructed using ultraviolet-stabilized thermoplastic for superior environmental resistance. It is easily mounted on standard 1 inch (IPS) pipe. An orientation ring preserves mounting position when the sensor is removed.

### 3.0 BEFORE INSTALLATION

The 86106 arrives fully calibrated and ready to use. Unless otherwise specified, the sensor is configured as follows:

#### FACTORY DEFAULT CONFIGURATION

RS-485/422 NMEA OUTPUT:  
 - Channel VI1.Y: Y Inverted  
 - Channel VI2.Z: Z Non-Inverted

If using the sensor with a NMEA 0183 compatible device, no further action is required. Simply connect the device as shown in Appendix A, figure A6.

Other options are described in APPENDIX A. These are accomplished using various jumper combinations and configuring settings using the 86SETUP program available at [www.youngusa.com](http://www.youngusa.com).

**Note: Always connect and bench test a complex system before installation in the field.**

## 4.0 INSTALLATION

### 4.1 PLACEMENT

Proper instrument placement is important. Eddies from buildings, trees, or other structures can influence measurements. For most applications, locate the sensor well above or upwind of obstructions. As a general rule, air flow around a structure is disturbed to 2 times the height of the structure upwind, 6 times the height downwind, and up to 2 times the height of the structure above ground.

### 4.2 MOUNTING AND ALIGNMENT

Mount the sensor to standard 1-inch (IPS) pipe that has an outside diameter of 1.34 inches (34 mm).

Most applications require aligning the sensor to geographic north (0 degrees). In this orientation the sensor junction box faces SOUTH (180 degrees). See the diagram in APPENDIX B.

- 4.2.1 Place orientation ring over pipe with guide pin up.
- 4.2.2 Place sensor mounting post over pipe.
- 4.2.3 Using the transducers as a sighting aid, align the sensor with a feature on the horizon that represents the proper orientation. After alignment, tighten the mounting post band clamp to secure the position. **DO NOT OVERTIGHTEN.**
- 4.2.4 Slide the orientation ring up so its guide pin is fully engaged in the sensor mounting post notch. Tighten the orientation ring band clamp to secure its position. **DO NOT OVERTIGHTEN.**

If the sensor needs to be removed later, leave the orientation ring on the pipe to preserve sensor alignment.

### 4.3 WIRING CONNECTIONS

With long cable lengths, resistance in the power supply wires reduces the available voltage at the sensor. Power at the sensor must be in the range of 10 to 30 VDC when the sensor is operating. See WIRING DIAGRAMS in APPENDIX A.

## 5.0 OPERATION

### 5.1 ANALOG OUTPUTS

As supplied, the sensor is configured for VOLTAGE OUTPUT, Wind Speed and Wind Direction. The sensor may also be set up for 4-20 mA CURRENT output by changing internal settings. Details are in section 6.0.

Analog VOLTAGE or 4-20mA CURRENT outputs may be connected to a datalogger or other device such as a YOUNG 26800 Meteorological Translator. See APPENDIX A for connection details.

Analog outputs may be used simultaneously with RS-232 serial connection. RS-485 serial output may not be used simultaneously with analog outputs since they share connection terminals in the junction box.

Analog outputs may be configured for either Polar (speed and direction) or Cartesian (UV) output format.

For voltage output with cable lengths greater than 3m (10 ft.), measure the signal differentially. Current output signals may be measured single-ended.

### 5.2 USE WITH YOUNG 06206 MARINE WIND TRACKER DISPLAY

The NMEA serial output format is compatible with the YOUNG Model 06206 Marine Wind Tracker display. Set the Wind Tracker input to 'INP SER' and connect as shown in the Wiring diagram, Fig A6, Appendix A. Note jumper configuration. Wind speed and direction measurements appear on the Wind Tracker display. See the Wind Tracker manual for display options and other details.

### 5.3 SERIAL OUTPUT FORMATS

Available serial output formats include RMYT, ASCII, ASCII polled, and NMEA. The factory default format is NMEA. Other formats may be selected using the 86SETUP program described in Section 6.0.

#### 5.3.1 RMYT

RMYT is a 6-byte binary data format sent at 9600 baud using

RS-485 OUTPUT ONLY mode. This is the factory default serial format for use with the YOUNG Model 06201 Wind Tracker.

#### 5.3.2 ASCII

ASCII output format provides continuous wind measurement data in text format at any of the available baud rates.

ASCII output appears either in POLAR (default) or CARTESIAN UV format. With POLAR format, the wind speed threshold, wind speed units, and resolution are user-selectable. With CARTESIAN the wind threshold is ignored and wind speed units are always meters per second (m/s).

#### ASCII POLAR FORMAT

```
a www.w ddd ss*cc<CR>      Low resolution
a www.ww ddd.d ss*cc<CR>    High resolution
```

#### where

a = Sensor address  
www.ww = Wind speed  
ddd.d = Wind direction  
ss = Status code  
\* = Asterisk (ASCII 42)  
cc = Checksum  
<CR> = Carriage return (ASCII 13)

#### ASCII CARTESIAN (UV) FORMAT

```
a uu.uu vv.vv ss*cc<CR>
```

#### where

a = Sensor address  
±uu.uu = U-axis wind speed (m/s)  
±vv.vv = V-axis wind speed (m/s)  
ss = Status code  
\* = Asterisk (ASCII 42)  
cc = Checksum  
<CR> = Carriage return (ASCII 13)

CHECKSUM is a two-character hexadecimal value (in printable ASCII format) generated by taking the exclusive-or of all characters up to the asterisk. STATUS CODE shows a non-zero value when the sensor cannot acquire sufficient samples or a measurement error has occurred.

#### 5.3.3 ASCII POLLED

ASCII POLLED is like ASCII format described above except just one serial output string is sent for each polling command received. The polling command is  $M_a!$  where 'a' is the sensor address (valid characters: 0-9, A-Z, a-z). The default address is '0' (ASCII 48).

### 5.3.4 NMEA

NMEA format provides continuous wind measurements in standard NMEA marine sentences at 4800 baud. Use RS-485 OUTPUT ONLY serial output mode with YOUNG Model 06206 Marine Wind Tracker or other NMEA-capable device.

#### NMEA FORMAT

```
$WIMWV,ddd,R,www.w,N,A*cc<CR><LF>
```

where

ddd = Wind direction (degrees)  
www.w = Wind speed (knots)  
\* = Asterisk (ASCII 42)  
cc = Checksum  
<CR><LF> = Carriage return, line feed (ASCII 13, 10)

CHECKSUM is the two-character printable hexadecimal value generated by taking the exclusive-or of all characters between '\$' and '\*'.  
'\$'

### 5.4 LOW POWER OPERATION

Average current consumption with default settings is about 20 mA. This configuration uses minimal power and enables all features even though they may not be used. This is suitable for many low power applications.

To reduce current consumption further, additional strategies include disabling unused outputs, using polled serial operation, increasing the output interval, and limiting the sample count to the minimum optimal number. Faster baud rates also reduce power by limiting transmit duration.

## 6.0 SETTING OUTPUTS AND OPERATING PARAMETERS

### 6.1 SENSOR CONFIGURATION WITH 86SETUP PROGRAM (RECOMMENDED)

The YOUNG 86SETUP program is available from the factory web site at [www.youngusa.com](http://www.youngusa.com). It provides an easy method for checking and configuring sensor operation. Install the program on a Windows PC and follow instructions that appear on the program screen to retrieve current sensor settings or send new settings.

### 6.2 SENSOR CONFIGURATION USING A GENERAL-PURPOSE COMMUNICATIONS PROGRAM

A general purpose text-based serial communications program like HyperTerminal may be used to manually configure the sensor by sending simple text commands.

The YOUNG sensor and communication program must operate at the same baud rate and be properly connected. Sensor RS-232 mode must be enabled. See the RS-232 Wiring diagram, Fig A3, in Appendix A.

Factory default sensor baud rate is 9600, but may be set to 1200, 4800, 19200 or 38400. Configure the serial communications program for NO handshaking and 1 start, 8 data, 1 stop bit.

The sensor must be in COMMAND MODE in order to set parameters. Enter COMMAND MODE by sending three ESC characters (ASCII 27) in quick succession while the sensor is running. When the sensor is in COMMAND MODE, it sends a '>' prompt character indicated that it is ready to accept commands.

If the prompt does not appear after sending three ESC characters, re-check wiring and communication program setup. If the sensor baud rate is unknown, try sending the ESC characters at each of the five available baud rates (1200, 4800, 9600, 19200 and 38400). It is also possible that sensor parameters have been purposely configured to disable RS-232 mode. If this the case, the following method must be used.

In order to provide access under all conditions, the sensor always begins operation at power up with serial communications set to 38400 baud and RS-232 connections enabled. Immediately after power up, there is a short time window in which to send the ESC characters and enter COMMAND MODE.

To use this feature, set your serial communication program baud rate to 38400. Remove power then wait 5 seconds. Re-apply power to the sensor. The sensor will transmit four asterisks immediately after power up. After the asterisks appear, send three ESC characters. The COMMAND MODE '>' prompt should appear.

### 6.3 COMMAND OVERVIEW

After the '>' prompt appears, send '??' to display a list of available commands. Send 'RPTV' to report current settings. (Note that some values in the report are for factory settings cannot be changed by the user.)

Commands are case sensitive and the exact format must be used. For example, the SET01nn command requires two digits for the serial format code. If you send SET014 instead of SET0104 the sensor will reject the command and indicate an error. End all commands with a carriage return (ASCII 13). In HyperTerminal, do this by pressing the ENTER key.

After receiving the carriage return, the sensor will evaluate the command. Valid commands will be executed. Current settings can be evaluated at any time by sending RPTV to get a new report.

#### IMPORTANT NOTE:

The YOUNG 86SETUP program automatically saves all settings to flash memory when they are sent to the sensor. Settings that are changed manually must be saved to flash with the SET77 command.

## 6.4 COMMAND DETAILS

COMMAND	DESCRIPTION
SET01nn	Set OUTPUT MODE
01	Enable voltage output
03	Enable current output
04	Enable RS-232
08	Enable RS-485 output only
16	Enable RS-485 half duplex
24	Enable RS-485 full duplex
SET02n	Set OUTPUT FORMAT
1	RMYT
2	ASCII
3	ASCII POLLED
4	NMEA
SET03nn	Set BAUD RATE
12	1200
48	4800
96	9600
19	19200
38	38400
SET04n	Set ASCII WS UNITS
1	MPH
2	KNOTS
3	KMPH
4	M/S
SET05c	ASCII character sensor address (0-9, A-Z, a-z)
SET06nnnn	Wind speed threshold for polar output (cm/s)
SET07nnnnn	Wind speed scale (nnnnn/10000)
SET08nnnnn	Direction offset (±nnnnn degrees x 10)
SET09nn	Damping factor
SET10nnnn	Output interval (0-9999 milliseconds)
SET11nn	Direction VOUT (36=0-360, 54=0-540 degrees)
SET12nnn	Sample count (3 to 200)
SET13n	Wind output format (0/1=Polar/UV)
SET14n	Analog error code (1/2/3=None/Lo/Hi)
SET15n	ASCII serial resolution(0/1=Lo/Hi)
SET16n	Force analog out (0/1/2=Lo/Mid/Hi)
SET77	SAVE SETTINGS
XX	Go to OPERATE MODE
RPT	Report parameter settings
??	Command Help list

### 6.4.1 SET01nn SET OUTPUT MODE

This enables and disables 0-5000 mV output, 4-20 mA current output, RS-232, and RS-485. Only one of the two analog output types (voltage or current) may be enabled at one time. Both RS-232 and RS-485 can be enabled at the same time but only one serial output may be used.

Add together values shown in 6.4 COMMANDS SET01 to configure multiple compatible modes. For example, to enable voltage output and RS-232, add the code for each one: 01 + 04 = 05, SET0105. To enable only RS-232, SET0104.

To conserve power, enable only those modes that are needed

### 6.4.2 SET02n OUTPUT FORMAT

This parameter determines the serial output format.

### 6.4.3 SET03nn BAUD RATE

Sets the baud rate for RS-232 and RS-485 serial communication. Make sure this baud rate is the same as the connected device.

### 6.4.4 SET04n ASCII and NMEA WIND SPEED UNITS

Sets wind speed units for polar ASCII, ASCII POLLED, and NMEA serial outputs.

### 6.4.5 SET05c POLL ADDRESS CHARACTER

Sets the sensor address for ASCII POLLED serial format. The default is '0' (ASCII 48). This is the address recognized when the 'Ma' polling command is received ('a' is the address character). Valid address characters include 0-9, A-Z, and a-z.

### 6.4.6 SET06nn WIND SPEED THRESHOLD

Sets the wind speed threshold for polar outputs (wind speed and direction) to minimize erratic wind direction indications at very low wind speeds. This allows the sensor output to mimic a mechanical wind vane that retains its orientation when there is no wind.

Wind below the threshold is reported as zero, while the wind direction angle is held at the last value when wind speed was above threshold. Set threshold in centimeters per second (m/s x 100). The default setting is 25 cm/s (0.25 m/s, 0.56 mph).

### 6.4.7 SET07nnnnn WIND SPEED MULTIPLIER

All wind speed measurements are multiplied by this parameter. The default value is 10000 for a multiplier of 1.0000.

### 6.4.8 SET08nnnnn WIND DIRECTION OFFSET

Use this parameter to add or subtract a wind direction offset. Value is degrees x 10 and may be positive or negative. Wind direction is always re-scaled to a 0-360 range after offset is applied. The default value is 00000.

### 6.4.9 SET09nn DAMPING FACTOR

Wind measurement outputs are damped using the following formula:

$$S_{\text{damped}} = [(d-1) * S_{\text{damped}} + S_{\text{sample}}] / d$$

where:

$$S_{\text{damped}} = \text{New or last damped wind speed}$$

$$S_{\text{sample}} = \text{New wind speed speed}$$

$$d = \text{Damping factor}$$

The default value is 00. This means no damping is applied. High damping values at long output intervals can slow the rate at which indicated wind values change.

### 6.4.10 SET10nnnn OUTPUT INTERVAL

Sets the time interval between measurements in one millisecond increments. Lower values increase power consumption when continuous measurements are taken.

### 6.4.11 SET11nn ANALOG DIRECTION SCALE

Sets wind direction analog output scale to 0-360 or 0-540 degrees. Use the 0-540 scale whenever possible to avoid full-scale analog output swings between 0 and 360 in variable north wind. (Data loggers or display systems may otherwise obtain samples midpoint during these transitions causing erroneous readings.)

Logged data in 0-540 form may be re-scaled to 0-360 by subtracting 360 degrees from any value greater than or equal to 360. The default parameter setting is 0-360 for systems that cannot re-scale the 0-540 output.

### 6.4.12 SET12nnn SAMPLE COUNT

The rate at which the sensor internally takes complete sonic wind samples is greater than 200 times per second. This command sets the number of internal samples used to calculate the median measurement result.

More internal samples consume more power while providing greater immunity to conditions like turbulent high-speed wind. Fewer samples consume less power while providing less immunity to disruptive conditions.

This command interacts with the OUTPUT INTERVAL setting. More samples may require a longer output interval.

#### 6.4.13 SET13n ASCII and ANALOG OUTPUT FORMAT

This setting determines whether ASCII and ASCII POLLED serial outputs and analog outputs provide wind data in either Polar (speed and direction) or Cartesian (UV) form.

#### 6.4.14 SET14n ANALOG OUTPUT STATUS

Serial ASCII and ASCII POLLED formats report a STATUS CODE where non-zero values indicate insufficient samples or measurement error. SET14n determines how the STATUS CODE is indicated by the analog output.

#### 6.4.15 SET15n ASCII RESOLUTION

Sets low or high wind speed and direction resolution.

#### 6.4.16 SET16n FORCE ANALOG OUTPUT

This command forces both analog output channels to LO, MID, or HI scale. This may be used to calibrate or check the operation of externally connected analog measurement devices.

#### 6.4.17 SET77 SAVE SETTINGS

Use this command to save current parameter settings to non-volatile memory. Any settings which have not been saved will be lost when power is removed. Saved settings are loaded at power up. This command may be used any time the sensor is in COMMAND MODE.

#### 6.4.16 XX, RPTV, and ??

XX	Returns the sensor to OPERATE MODE.
RPT	Reports the current parameter settings.
??	Shows a list of commands.

## 7.0 EXAMPLE SETTINGS

---

Suggested settings. Not all possible setting combinations are shown. Using YOUNG 86SETUP program for changing parameters is recommended. See wiring diagrams for jumper settings.

### 7.1 FACTORY DEFAULT

RS-232	Enabled
RS-485 Output Only	Enabled
Voltage Output:	Enabled
Current Output:	Disabled
Serial Output Format:	NMEA
Output Interval	500
Sample Count:	100

### 7.2 MINIMUM POWER

RS-232	Enabled
RS-485	Disabled
Voltage Output:	Disabled
Current Output:	Disabled
Serial Output Format:	ASCII
Output Interval	1000
Sample Count:	16

### 7.3 4-20 mA OUTPUT

RS-232	Enabled
RS-485	Disabled
Voltage Output:	Disabled
Current Output:	Enabled
Output Interval	1000
Sample Count:	100

### 7.4 RS-485 POLLED ASCII OUTPUT

RS-232	Enabled
RS-485	Enabled
Voltage Output:	Disabled
Current Output:	Disabled
Serial Output Format:	ASCII POLLED
Sample Count:	100

### 7.5 HIGH WINDS

Output Delay:	1000
Sample Count:	200

## 8.0 EMC COMPLIANCE

---

This sensor complies with limits for a Class A digital device, pursuant to part 15 of the FCC Rules, and IEC standard 61326-1. This sensor generates, uses, and can radiate radio frequency energy and, if not installed and used in accordance with the instruction manual, may cause harmful interference to radio communications. Sensor operation may be temporarily affected by radio frequency and transient interference sources, but will revert to proper operation when the source of interference is removed.

## 9.0 WARRANTY

---

This product is warranted to be free of defects in materials and construction for a period of 12 months from date of initial purchase. Liability is limited to repair or replacement of the defective item. A copy of the warranty policy may be obtained from R. M. Young Company.





# APPENDIX A: WIRING CONNECTIONS

MODEL 86106

## VOLTAGE OUTPUT

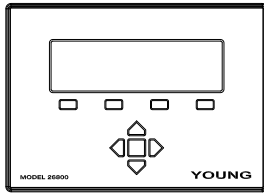

Model 26800 Translator, Datalogger, or other voltage measuring device

### SETTINGS

Output Mode: VOUT  
 WD Output Scale: 0-360 or 0-540 degrees  
 Wind Format: Polar or UV  
 Analog Output Error Code: None, Low, or High

### CALIBRATION:

0 to 5000 mV  
 Polar Wind Speed: 0 to 100 m/s  
 Wind Direction: 0 to 360° or 0 to 540°  
 U or V: -100 m/s to +100 m/s

For best accuracy measure output voltage differentially as shown. Use shielded cable. Connect cable shield to earth ground as shown.

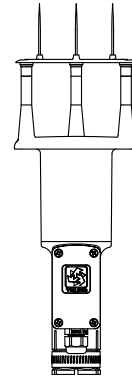

Model 86000 / 86106 Ultrasonic Anemometer

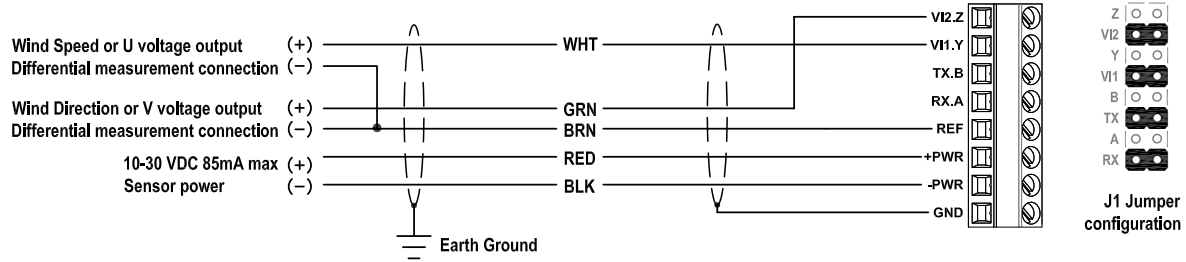

## 4-20 mA CURRENT OUTPUT

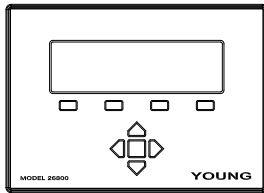

Model 26800 Translator, Datalogger, or other current measuring device

### SETTINGS

Output Mode: IOUT  
 WD Output Scale: 0-360 or 0-540 degrees  
 Wind Format: Polar or UV  
 Analog Output Error Code: None, Low, or High

### CALIBRATION:

4.00 to 20.00 mA  
 Polar Wind Speed: 0 to 100 m/s  
 Wind Direction: 0 to 360° or 0 to 540°  
 U or V: -100 m/s to +100 m/s

Use shielded cable. Connect cable shield to earth ground as shown.

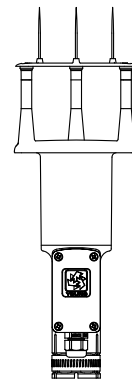

Model 86000 / 86106 Ultrasonic Anemometer

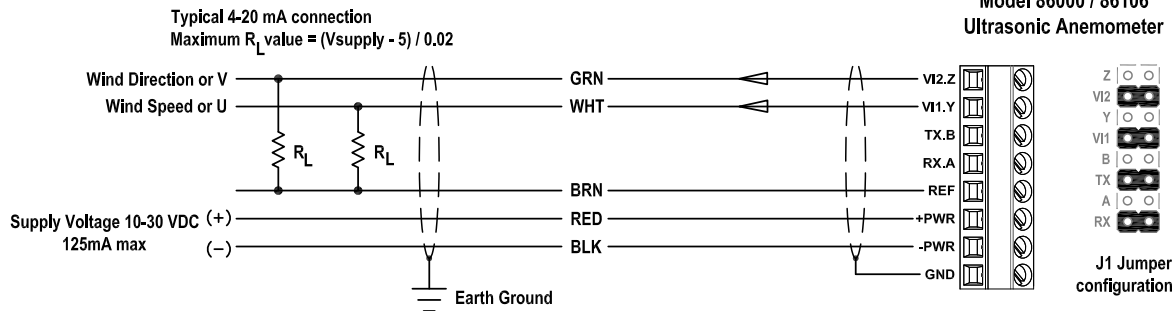



# APPENDIX A: WIRING CONNECTIONS

MODEL 86106

## RS-232 SERIAL CONNECTION

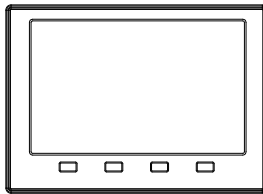

Serial Device

### SETTINGS

Output Mode: RS-232  
 Output Format: ASCII, ASCII POLLED, NMEA, or RMYT  
 Baud Rate: 1200, 4800, 9600, 19200 or 38400

Set connected serial device baud rate to match sensor.  
 1 start bit, 8 data bits, no parity, 1 stop bit, no flow control.

Use shielded cable. Connect cable shield to earth ground as shown.

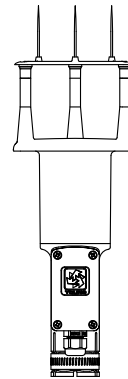

Model 86000 / 86106  
Ultrasonic Anemometer

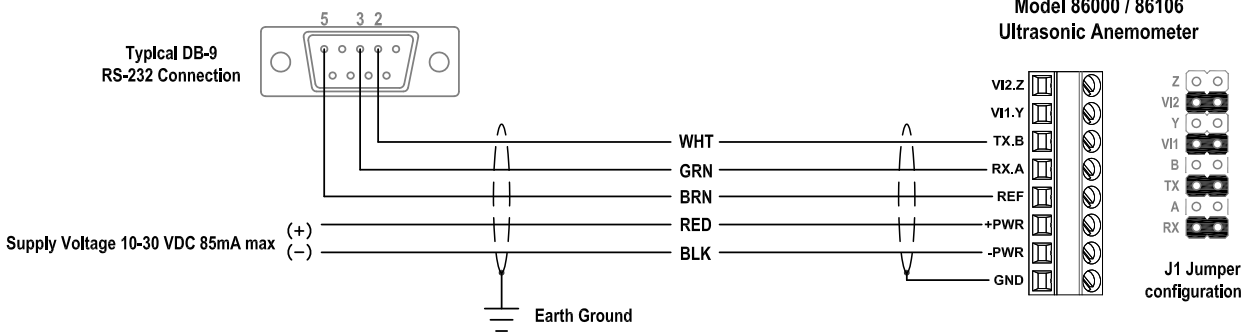

## RS-485 SERIAL CONNECTION - FULL DUPLEX

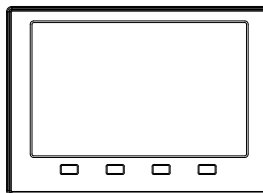

Serial Device

### SETTINGS

Output Mode: RS-485 Full Duplex  
 Output Format: ASCII, ASCII POLLED\*, NMEA, or RMYT  
 Baud Rate: 1200, 4800, 9600, 19200 or 38400

Set connected device baud rate to match sensor.  
 1 start bit, 8 data bits, no parity, 1 stop bit, no flow control.

Use shielded cable. Connect cable shield to earth ground as shown.

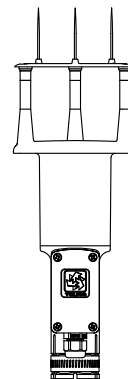

Model 86000 / 86106  
Ultrasonic Anemometer

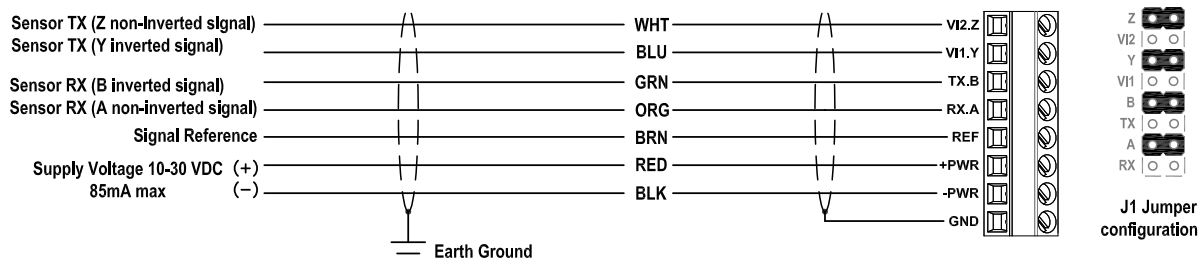



# APPENDIX A: WIRING CONNECTIONS

MODEL 86106

## RS-485 SERIAL CONNECTION - HALF DUPLEX

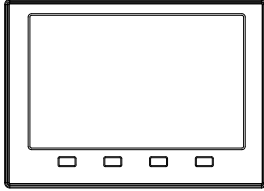

Serial Device

### SETTINGS

Output Mode: RS-485 Half Duplex  
 Output Format: ASCII, ASCII POLLED\*, NMEA, or RMYT  
 Baud Rate: 1200, 4800, 9600, 19200 or 38400

Set connected device baud rate to match sensor.  
 1 start bit, 8 data bits, no parity, 1 stop bit, no flow control.

Use shielded cable. Connect cable shield to earth ground as shown.

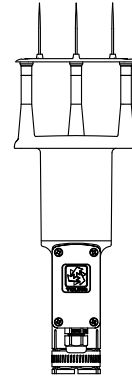

Model 86000 / 86106  
Ultrasonic Anemometer

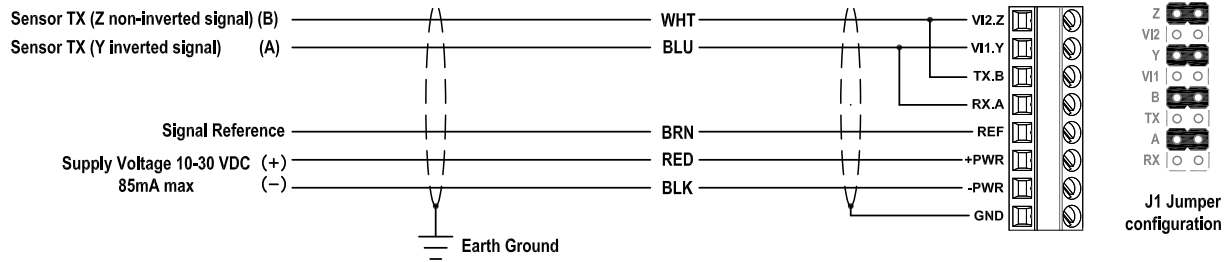



# APPENDIX A: WIRING CONNECTIONS

MODEL 86106

## 06201 WIND TRACKER

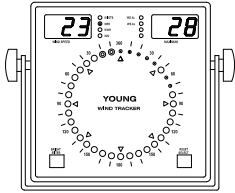

Model 06201  
Wind Tracker

**SETTINGS:**  
 Output Mode: RS-485 Output Only  
 Output Format: RMYT  
 Baud Rate: 9600

These are the default sensor settings as shipped unless otherwise requested. Use shielded cable. Connect earth ground as shown.

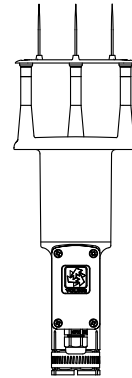

Model 86000 / 86106  
Ultrasonic Anemometer

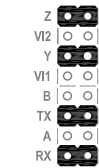
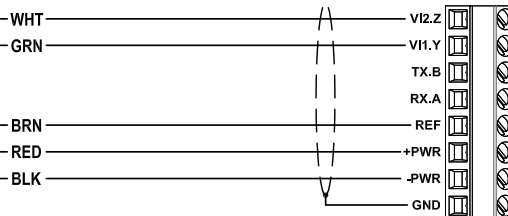
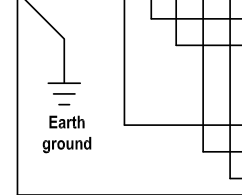
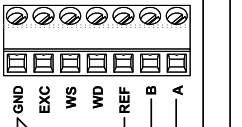
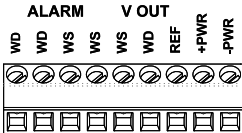

Output Jumper  
J1 Configuration

## 06206 MARINE WIND TRACKER

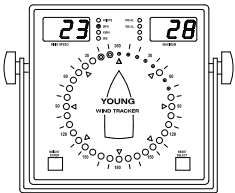

Model 06206  
Wind Tracker

**SETTINGS:**  
 Output Mode: RS-485 Output Only  
 Output Format: NMEA  
 Baud Rate: 4800

Use shielded cable. Connect earth ground as shown.

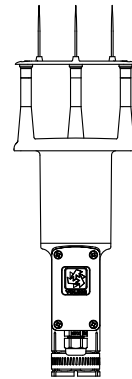

Model 86000 / 86106  
Ultrasonic Anemometer

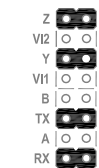
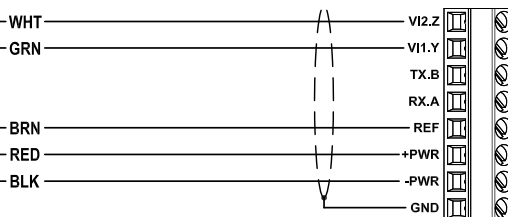
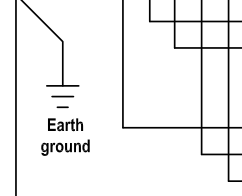
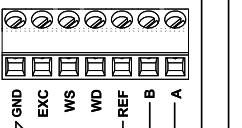
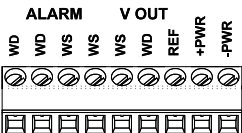

Output Jumper  
J1 Configuration



# APPENDIX B: SENSOR ORIENTATION AND DIMENSIONS

MODEL 86106

