



USER MANUAL

Pronto-Si | Pocket-Size 800 mW Power Probe

WARRANTY

All Gentec-EO products carry a one-year warranty from the date of shipment on material or workmanship defects when used under normal operating conditions.

Gentec-EO will repair or replace, at its sole discretion, any product that proves to be defective during the warranty period.

The warranty does not cover damages caused by product misuse, product modifications, accidents, abnormal operating or handling conditions, or third-party battery leakage. Any attempt by an unauthorized person to alter or repair the product voids the warranty. Gentec-EO is not liable for consequential damages of any kind.

CLAIMS

For warranty service, please contact your Gentec-EO representative or fill out an RMA request:

<https://www.gentec-eo.com/contact-us/support-rma-request>

To help us answer your request more efficiently, please have your product serial number ready before contacting customer support.

Upon receipt of return authorization, ship the product according to the RMA instructions. Do not ship items without a return authorization. Transport is at the customer's expense, in both directions, unless the product has been received damaged or non-functional. Gentec-EO assumes no responsibility for the damage caused in transit.

SAFETY INFORMATION

Do not use a Gentec-EO device if the monitor or the detector looks damaged or if you suspect that the device is not operating properly.

Appropriate installation must be done for water-cooled and fan-cooled detectors. Refer to the specific instructions for more information. Wait a few minutes before handling the detectors after they are powered up. The surfaces of the detectors get very hot, and there is a risk of injury if they have not cooled.

Note: This equipment has been tested and found to comply with the limits for a Class A digital device, pursuant to part 15 of the FCC Rules. These limits are designed to provide reasonable protection against harmful interference in a residential installation. This equipment generates, uses and can radiate radio frequency energy. If not installed and used in accordance with the instructions, it may cause harmful interference to radio communications. However, there is no guarantee that interference will not occur in a particular installation. If this equipment does cause harmful interference to radio or television reception, which can be determined by turning the equipment off and on, try to correct the interference by taking one or more of the following steps:

- Reorient or relocate the receiving antenna.
- Increase the distance between the equipment and receiver.
- Connect the equipment to an outlet that is on a different circuit than the receiver.
- Consult the dealer or an experienced radio/TV technician for help.

Caution: Changes or modifications not expressly approved in writing by Gentec-EO Inc. may void the user's authority to operate this equipment.

SYMBOL

The following international symbol is used in this manual:



Refer to the manual for specific warning or caution information to avoid any damage to the product.

Table of contents

1.	PRONTO-Si handheld laser probe.....	6
1.1.	Included with your PRONTO-Si.....	6
1.2.	Introduction.....	6
1.3.	Warnings and disclaimer.....	6
1.4.	Specifications.....	7
1.5.	Mechanical description.....	9
2.	User interface.....	10
2.1.	List of icons.....	10
2.2.	Description of the screens.....	11
3.	Operating Instructions.....	13
3.1.	Turning the device on and off.....	13
3.2.	Changing the settings.....	13
3.2.1.	Changing the wavelength.....	13
3.2.2.	Opening and closing the settings menu.....	14
3.2.3.	Changing the orientation of the screen.....	14
3.2.4.	Changing the brightness of the screen.....	14
3.2.5.	Getting information about the device.....	14
3.3.	Zeroing.....	15
3.4.	Making a measurement.....	15
3.5.	Acquiring, transferring and deleting data.....	16
3.5.1.	Acquiring data.....	16
3.5.2.	Transferring data.....	16
3.5.3.	Deleting the data.....	16
4.	USB communication.....	17
4.1.	Description.....	17
4.2.	Setting up communication with the PRONTO.....	17
4.2.1.	Connect the PRONTO.....	17
4.2.2.	To echo commands.....	17
4.2.3.	Test the connection.....	17
4.3.	Serial command format.....	18
4.3.1.	Serial protocol rules.....	18
4.3.2.	Text mode rules.....	18
4.4.	List of serial commands for the PRONTO (summary).....	19
4.5.	Detailed description of the serial commands for PRONTO (complete).....	20
4.5.1.	Display.....	20

4.5.2.	Data acquisition.....	23
4.5.3.	Setup	24
4.5.4.	Control.....	25
4.5.5.	Instrument and detector information.....	27
4.6.	Error messages.....	32
5.	Safety instructions.....	32
5.1.	General	32
5.2.	Damage to the optical absorber material	32
5.3.	How to properly handle the device.....	32
6.	Sources of error	33
6.1.	Zero offset	33
6.2.	Offset drift due to temperature.....	33
6.3.	Wavelength.....	34
6.4.	Maximum power.....	35
7.	Maintenance.....	36
7.1.	Free firmware upgrade.....	36
8.	Accessories	36
8.1.	Threaded adaptor.....	36
9.	Declaration of conformity	39
10.	UKCA declaration of conformity.....	40
11.	Appendix A: WEEE Directive	41
12.	Appendix B: Installing the ProntoDataTransfer software	42
13.	Addendum.....	44

1. PRONTO-SI HANDHELD LASER PROBE

1.1. INCLUDED WITH YOUR PRONTO-SI

The items below are included with the PRONTO-Si.

Description	Part name	Part number
PRONTO-Si laser power monitor		
1.8 m USB-A to USB-mini cable	MAE-USB	202372
Carrying case		
Calibration certificate		

The accessories below can be purchased separately.

Description	Part name	Part number
Internally threaded SM1 adaptor for the PRONTO-Si		203502
Stand (steel post)	STAND-S-233	200160

1.2. INTRODUCTION

The PRONTO-Si laser probe is designed to be used at low average power densities. It can measure between 20 pW and 800 mW (at 600 nm).

The PRONTO-Si can be supplied with an optional stand or a power supply.

Call your nearest Gentec-EO distributor to repair or recalibrate a PRONTO-Si. To find the nearest Gentec-EO office or distributor in your country, go to www.gentec-eo.com/contact-us.

1.3. WARNINGS AND DISCLAIMER

In no event shall Gentec-EO or any of its affiliates be liable for any indirect, special, incidental, or consequential injury to persons or damage to property caused by the use of any of our products, by purchasing from Gentec-EO or any of its affiliates, you hereby indicate that you understand and agree to the disclaimer below.



Disclaimer

I am fully responsible for the safe application and use of this detector and agree to such by completing the sales process.

I will not use a laser device without wearing approved laser safety goggles designed for such a purpose.

I am aware and responsible for safely dealing with any back reflections.

I will not use the detector in violation of any local, state or federal law and I understand that it is my responsibility to know and abide by those laws relating to the ownership and use of the detector in my jurisdiction.

1.4. SPECIFICATIONS

The following specifications are based on a one-year calibration cycle, an operating temperature of 15 °C to 28 °C (59 °F to 82 °F) and a relative humidity not exceeding 80%. Monitors must be stored in an environment between 10 °C to 60 °C (50 °F to 140 °F) and a relative humidity not exceeding 90%.

	PRONTO-Si	
Interface	Touch screen	
Display	Color LCD 28 mm x 35 mm (128 x 160 pixels)	
Measurement controls	Zero offset, wavelength selection and reset data	
Data acquisition and transfer	On/off controls Maximum of 50,000 measurements Acquisition frequency of 6.8 Hz	
Screen personalization	Four screen orientations and four brightness levels	
Saved settings	Screen orientation Screen brightness Wavelength	
Effective aperture	10 mm x 10 mm	
Calibrated spectral range	<u>Attenuator off</u> 320 – 1100 nm	<u>Attenuator on</u> 400 – 1100 nm
Power noise level	20 pW at 1064 nm	
Response time (10% - 90%)	0.2 sec	
Typical sensitivity	0.71 A/W at 980 nm 0.33 A/W at 1064 nm	
ADC	24 bits, 6.8 Hz bandwidth	
Minimum repetition rate for average power measurements of a pulse laser	100 Hz	
Calibration uncertainty	<u>Attenuator off</u> 320 - 399 nm ± 6.0% 400 - 449 nm ± 2.0% 450 - 809 nm ± 1.5% 810 - 899 nm ± 2.0% 900 - 1009 nm ± 4.0% 1010 - 1100 nm ± 7.5%	<u>Attenuator on</u> 400 - 899 nm ± 4.0% 900 - 1009 nm ± 5.0% 1010 - 1100 nm ± 7.5%
Linearity with power	± 2%	
Repeatability (precision)	± 0.5%	
Power resolution	1 pW	
Maximum power at 600 nm	<u>Attenuator off</u> 65 mW	<u>Attenuator on</u> 800 mW
Maximum power at 980 nm	<u>Attenuator off</u> 40 mW	<u>Attenuator on</u> 200 mW
Maximum power at 1064 nm	<u>Attenuator off</u> 80 mW	<u>Attenuator on</u> 600 mW
Maximum average power density	40 mW/cm ² at 980 nm 80 mW/cm ² at 1064 nm	

	PRONTO-Si
Operating conditions	Ambient temperature: 15 °C - 28 °C Maximum Relative humidity: 80%
Damage Threshold	100 W/cm ²
Absorber	Silicon
Attenuator	Integrated slide-in OD1 attenuator
Dimensions Open Closed	41.0 W x 216.2 L x 15.8 D mm 41.0 W x 136.0 L x 22.1 D mm
Weight	155 g
Battery type	USB Rechargeable Li-ion
Battery life (time before the battery needs to be charged via the USB port)	17 hours (with brightness set at 25%) Charge time: 7.5 hours when empty
Maximum battery cycle count (amount of charge cycles before the battery loses its efficiency)	Approximately 500 full charges (0-100%)
Lithium battery transport compliance	UN: Recommendations on the Transport of Dangerous Goods, Manual of Tests and Criteria, ST/SG/AC.10/11/Rev.6/Amend.1 Section 38.3 ¹
Mounting holes (for post)	1 x 8-32

Specifications are subject to change without notice.

¹ UN38.3 certificate available upon request.

1.5. MECHANICAL DESCRIPTION



















Figure 1. PRONTO-Si mechanics

- 1** **Sensor**
The laser must be centered on the absorber when making a measurement.
- 2** **Slide-in attenuator**
The position of the OD1 integrated filter is known, and the measured power is automatically adjusted.
- 3** **Mounting hole**
There is an 8-32 mounting hole to fit the device on a post for safer use during the measurements.
- 4** **Touchscreen display and controls**
The touchscreen interface controls the device.
- 5** **On/off/settings button**
This button is used to turn the device on (press when the device is off) and off (press and hold for 3 seconds when the device is on). It is also used to access the settings menu (press when the device is on).
- 6** **USB Port**
The Mini-B USB 2.0 port is used to transfer data from the device to a PC and to charge the battery.

2. USER INTERFACE

2.1. LIST OF ICONS

ICON	NAME	DESCRIPTION
	Battery	Indicates the battery level. If the battery icon is red, recharge immediately. The yellow lightning sign indicates the battery is charging.
	Bar-graph	Press → switches to bar-graph mode
	Min/Max	Press → switches to min/max mode
	Real-time	Press → switches to real-time mode
	Wavelength	Press → opens the wavelength menu
	Data acquisition	Press → starts data acquisition
		Press and hold → erases the saved data
		Press → stops data acquisition
	Reset	Press → sets the minimum and maximum values to the current power
	Up	Press → increments the selected units
	Down	Press → decrements the selected units
	About	Press → opens the about menu
	Screen orientation	Indicates the screen orientation (four options)
		Press → toggles to the next orientation
	Brightness	Indicates the screen's brightness level (four options)
		Press → toggles to the next brightness level
	Zero	Press → calculates and activates the zero offset for all the ranges
		Press → deactivates the zero offset

2.2. DESCRIPTION OF THE SCREENS

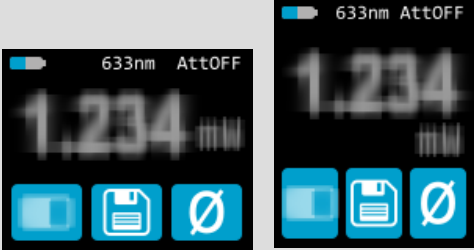
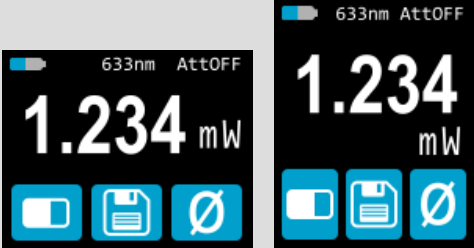
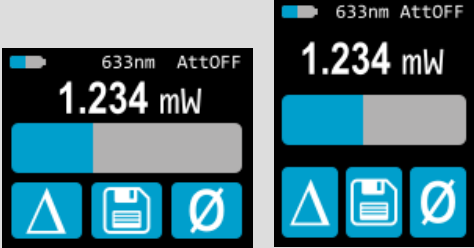
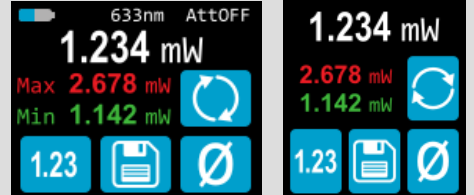
SCREEN	FUNCTIONS
Common features	
	<p>Top row:</p> <ul style="list-style-type: none"> ▶ Displays the battery indicator, wavelength, and attenuator on/off state. <p>Bottom row:</p> <ul style="list-style-type: none"> ▶ Left button toggles between the three display modes (real-time, bar-graph, and min/max). ▶ When the data acquisition button is white, the measured power is logged in the internal memory. ▶ When the zero button is white, the offset is applied to the measured power.
Real-time mode	
	<ul style="list-style-type: none"> ▶ Displays the measured power in real-time.
Bar-graph mode	
	<ul style="list-style-type: none"> ▶ Displays the measured power in real-time. ▶ Displays a bar graph of the current scale.
Min/max mode	
	<ul style="list-style-type: none"> ▶ Displays the measured power in real-time. ▶ Displays minimum power (in green) and maximum power (in red) since the last reset.

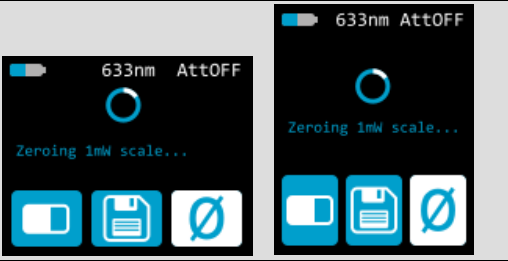
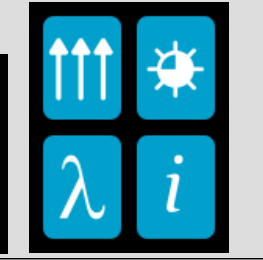
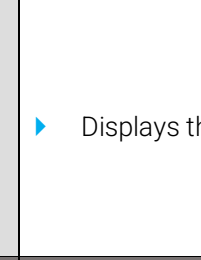
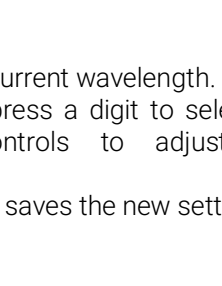
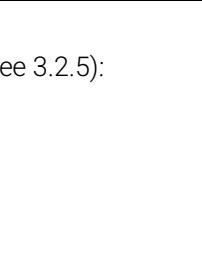
SCREEN	FUNCTIONS
Zeroing	
	<ul style="list-style-type: none"> ▶ The PRONTO is setting the zero offset for all ranges to ensure the accuracy of the measurements (see 3.3).
Settings	
	<ul style="list-style-type: none"> ▶ Displays the settings controls and menus. ▶ Automatically saves the orientation (see 3.2.3) and brightness (3.2.4) upon exit.
Wavelength menu	
	<ul style="list-style-type: none"> ▶ Displays the wavelength presets (see 3.2.1)
Set wavelength	
	<ul style="list-style-type: none"> ▶ Displays the current wavelength. ▶ Users must press a digit to select it and press the up/down controls to adjust the wavelength (see 3.2.1). ▶ Automatically saves the new settings upon exit.
About	
	<ul style="list-style-type: none"> ▶ Displays the following information (see 3.2.5): <ul style="list-style-type: none"> • Model name • Serial number • Firmware • Last calibration date

3. OPERATING INSTRUCTIONS

3.1. TURNING THE DEVICE ON AND OFF

Turn on: Press the on/off/settings button .

Turn off: Press and hold the on/off/settings button for 3 seconds.



Tip

The device will automatically turn off after 5 minutes of inactivity, except if data is being acquired. When the device is plugged into a PC via the USB cable, it will turn on and stay on until it is manually turned off or unplugged.

3.2. CHANGING THE SETTINGS

3.2.1. Changing the wavelength

Before making a measurement, it is important that you adjust the calibration of the device to the wavelength of the source to be measured.

1. Press the on/off/settings button to access the settings menu
2. Press the wavelength button  to display a list of presets.



Figure 2. The six wavelength buttons can be customized by the user

There are six presets in the wavelength menu. The values can be set to any wavelength between 320 nm and 1100 nm. To change a value, press it until the screen changes to the set wavelength menu. Each digit is changed individually by selecting it and pressing the up/down arrows. For example, if you want to change 1064 nm to 532 nm, you need to do the following:

1. Select the 1st number. Make sure it turns blue **1064** and use the down button to reduce it to 0.
2. Select the 2nd number. Make sure it turns blue **0064** and use the up button to increase it to 5.
3. Select the 3rd number. Make sure it turns blue **0564** and use the down button to reduce it to 3.
4. Select the 4th number. Make sure it turns blue **0534** and use the down button to reduce it to 2.
5. You're done! **0532**

Once the desired value is entered, press the on/off/settings button to exit the menu and automatically save your new settings.

3.2.2. Opening and closing the settings menu

When the device is on, press the on/off/settings button to access the menu. Pressing the button again will close it and save whatever settings have been changed.

3.2.3. Changing the orientation of the screen

There are four possible screen orientations: up, down, left, and right. The button displays the current

orientation, for example, up: . To change the orientation, simply press the button, and the next choice will appear. The changes will be saved once you exit the settings menu.

3.2.4. Changing the brightness of the screen

There are four possible brightness levels: 100%, 75%, 50% and 25%. The button displays the current

brightness, for example, 75%: . To change the brightness, simply press the button, and the next choice will appear. The changes will be saved once you exit the settings menu.

3.2.5. Getting information about the device

Relevant information about the device is stored in the about menu . This information can be useful when returning the device for repairs or recalibration. These include the model name, serial number, firmware version, and the last calibration date.

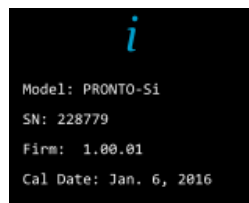



Figure 3. The about menu displays important information about your device

Press the on/off/settings button to exit the menu and go back to the measurement screen.

3.3. ZEROING

1. Make sure the attenuator is in the appropriate position for your measurements (the zero offset must be recalculated when the attenuator changes position).
2. Block off any laser radiation to the detector.
3. To reset the zero, wait until the reading has stabilized. The power read by the device when no laser beam is incident on the sensor may not be exactly zero if the device is not thermally stabilized. Warm up until the reading without laser power is stable for several minutes. Half an hour warm-up is recommended for measuring low powers precisely.
4. Press the zero  button. The device passes through all the scales to determine the compensation to null each one. When the process is complete, the device returns to the measurement screen and you are now ready to make an accurate measurement.

When the offset is applied to the measurement, the zero button is white . The offset stays active until the zero button is pressed again or until the PRONTO-Si is turned off.



3.4. MAKING A MEASUREMENT

Once all the settings are adjusted, you are ready to make a measurement. Just follow the step-by-step instructions below.

1. Turn the device on.
2. Select the wavelength closest to the laser light you want to measure (see Section 3.2.1).
3. For maximum accuracy, adjust the reading to zero before making the measurements (see Section 3.3). For low-power measurements, the sensor must be protected from ambient light and ideally used in the dark.
4. Place the device in the laser beam path. The entire laser beam must be within the aperture of the sensor. Do not exceed maximum specified densities, energies, or power. For the most accurate measurement, spread the beam across 90% of the area.
5. The device will automatically display the power value.

3.5. ACQUIRING, TRANSFERRING AND DELETING DATA

3.5.1. Acquiring data

You can store the measurements done by the device simply by pressing the save button . When pressed, the button turns white  to indicate that the data is being stored in the internal memory of the device. Once activated, the data acquisition will stay active until stopped or if the device is turned off and on. To stop the data acquisition, press the save button again, and it will revert to its original state.



When acquiring data, the PRONTO-Si does not automatically shut down, even if the head is flipped closed.

3.5.2. Transferring data

To retrieve the data, you must connect the PRONTO-Si to your computer with a USB cable and use the ProntoDataTransfer software . You can download our latest version of the software in the Downloads section of our website (<https://gentec-eo.com/downloads>). The data will be uploaded on your computer in a text format, which you can save to a known location on your computer and then open in your preferred analysis software.



Once the data has been transferred to a computer, it is deleted from the internal memory of the device.



Figure 4. Transferring measurements acquired with a PRONTO-Si to a computer

Complete installation and data transfer instructions can be found in Appendix B: Installing the ProntoDataTransfer software.

3.5.3. Deleting the data

To delete the data from the internal memory, you must hold the save button for approximately 3 seconds. A text will appear and ask, "Erase all data?". Press the yes button, then click OK.

4. USB COMMUNICATION

4.1. DESCRIPTION

The PRONTO has one communication mode: ASCII. The format will require text input commands which follow the rules stated in section 0. The section 0 describes all the commands.

The USB class used by the PRONTO is a CDC or communications device class. This means it shows up in the host PC as a COM port, it is not a COM port, but rather a true full-speed USB port. You can talk to it as if it were an RS232 port, but much faster. Follow the Windows Prompts to install the USB drivers. The USB drivers are fully tested and digitally signed by Microsoft.

Open the appropriate port in your software with standard COM port tools. None of the port settings matter since they are not used, so leave them at whatever default they are in. It is a real USB connection.

Use the standard COM port write and read protocols to control the PRONTO.

4.2. SETTING UP COMMUNICATION WITH THE PRONTO

4.2.1. Connect the PRONTO

Use your favorite serial terminal emulator to connect to the COM port. Some example serial terminal programs are

- CoolTerm: <https://freeware.the-meiers.org/>
- PuTTY: <http://www.putty.org/>
- RealTerm: <https://realterm.sourceforge.io/>

If you need to know the COM port number, you can find it in Windows Device Manager.

Use the following communication parameter settings:

PRONTO COM port settings	
Bits per second	Any setting will work
Data bits	Any setting will work
Parity	Any setting will work
Stop bits	Any setting will work
Flow control	Any setting will work

4.2.2. To echo commands

The commands you type will not appear in the terminal window unless you set up the terminal emulator to do so. Only the response from the monitor will be displayed. If you prefer to see the commands you are typing, enable "Local Echo" or an equivalent setting.

4.2.3. Test the connection

In the terminal window, type *VER. If the response is the version of your monitor, you are successfully connected and ready for serial command action.

4.3. SERIAL COMMAND FORMAT

4.3.1. Serial protocol rules

Commands are sent as text strings. The response will either be data or an empty string.

4.3.2. Text mode rules

All text commands must begin with a trig character (*). You do not need to end with a line feed or a carriage return. Parameters must NOT be separated by spaces. Characters do not have to be capitals, mixed upper and lower cases are OK. Replies to all text mode commands are also in text mode and end with a carriage return and a line feed.

In case of an error, the reply string is one of the following:

"Command Error. Command not recognized."

or

"Command Error. Command must start with '*'"

Because all text mode replies end with a carriage return <CR> or line feed <LF> (or both), a text reply contains tabulations when many elements need to be separated in the string. This is useful when exporting data to a spreadsheet.

4.4. LIST OF SERIAL COMMANDS FOR THE PRONTO (SUMMARY)

#	Command Name	Command	Description
Display			
01	Set scale	SCS	Manually sets the scale
02	Set scale up	SSU	Changes scale to the next higher scale
03	Set scale down	SSD	Changes scale to the next lower scale
04	Get current scale index	GCR	Returns scale index between 0 and 41
05	Set autoscale	SAS	Sets the autoscale
06	Get autoscale	GAS	Returns autoscale status
07	Display valid scale	DVS	Displays the valid scales for the connected head
08	Get measure mode display	GMD	Returns the current measure mode on PRONTO
09	Control LCD	LCD	Turns on/off the LCD
Measurement			
Data acquisition			
10	Query current value	CVU	Gets the value currently in ASCII or binary
11	Send continuous transmission of data	CAU	Sends the values in ASCII or binary to the serial port with the data sampling setting
12	Stop the CAU command	CSU	Stops the *CAU command
13	Query new value ready	NVU	Determines if new reading is available or not
Setup			
14	Set personal wavelength correction in nm	PWC	Specifies the wavelength in nm
15	Get wavelength	GWL	Returns the wavelength in nm
16	Get attenuator position	GAT	Returns on or off depending on the attenuator position
Control			
17	Set zero offset	SDZ	Zeroes the reading for a value without offset
18	Clear zero offset	COU	Undoes the zeroing of the reading for a power detector
19	Get zero offset	GZO	Returns the zero offset status
20	Set user multiplier	MUL	Sets the multiplier value
21	Get user multiplier	GUM	Returns the current multiplier value
22	Set user offset	OFF	Sets the offset value
23	Get user offset	GUO	Returns the current offset value
Instrument and detector Information			
24	Query version	VER	Gets firmware version of the monitor
25	Query status	STS	Retrieves the detector information and monitor settings
26	Query extended status	ST2	Returns the extended status
27	Return instrument ID	IDN	Returns the device model
28	Return instrument firmware	GSV	Returns the firmware version
29	Return global information	GFW	Returns the firmware identification number, the device model, and the firmware version
30	Query battery state	QSO	Returns the battery level

4.5. DETAILED DESCRIPTION OF THE SERIAL COMMANDS FOR PRONTO (COMPLETE)

4.5.1. Display

01 - Set Scale

This command is used to force the display of the current data into a specific scale. The lower scale is always zero, the higher scales can be found in the table below. The autoscale mode applies the best scale for the current values in real-time. The parameter must be one of the identifiers in the table below and have two digits.

Command	Parameters	Answer
SCS	Range index	

Range identifiers

Index	Value	Index	Value
00	1 picowatt or picojoule	21	30 milliwatts or millijoules
01	3 picowatts or picojoules	22	100 milliwatts or millijoules
02	10 picowatts or picojoules	23	300 milliwatts or millijoules
03	30 picowatts or picojoules	24	1 watt or joule
04	100 picowatts or picojoules	25	3 watts or joules
05	300 picowatts or picojoules	26	10 watts or joules
06	1 nanowatt or nanojoule	27	30 watts or joules
07	3 nanowatts or nanojoules	28	100 watts or joules
08	10 nanowatts or nanojoules	29	300 watts or joules
09	30 nanowatts or nanojoules	30	1 kilowatt or kilojoule
10	100 nanowatts or nanojoules	31	3 kilowatts or kilojoules
11	300 nanowatts or nanojoules	32	10 kilowatts or kilojoules
12	1 microwatt or microjoule	33	30 kilowatts or kilojoules
13	3 microwatts or microjoules	34	100 kilowatts or kilojoules
14	10 microwatts or microjoules	35	300 kilowatts or kilojoules
15	30 microwatts or microjoules	36	1 megawatt or megajoule
16	100 microwatts or microjoules	37	3 megawatts or megajoules
17	300 microwatts or microjoules	38	10 megawatts or megajoules
18	1 milliwatt or millijoule	39	30 megawatts or megajoules
19	3 milliwatts or millijoules	40	100 megawatts or megajoules
20	10 milliwatts or millijoules	41	300 megawatts or megajoules

Default: Autoscale



Example

The following example sets the scale to 3 nanowatts or nanojoules:

Command: *SCS07

Answer:

02 - Set scale up

This command is used to force the display of the current data to a higher scale.

Command	Parameters	Answer
SSU	None	

03 - Set scale down

This command is used to force the display of the current data into a lower scale.

Command	Parameters	Answer
SSD	None	

04 - Get current scale index

This command returns the scale index between 0 and 41. Please refer to the set scale command (SCS) details for the complete scale index table.

Command	Parameters	Answer
GCR	None	Index from 0 to 41

**Example**

Command: *GCR

Answer: Range: 10<CR><LF>

05 - Set autoscale

This command is used to force the display into autoscale.

Command	Parameters	Answer
SAS	1: On 0: Off	

06 - Get autoscale

This command returns whether or not the autoscale option is activated.

Command	Parameters	Answer
GAS	None	1: On 0: Off

**Example**

Command: *GAS

Answer: AutoScale: 1<CR><LF>

07 - Display valid scale

This command is used to display all the valid scales that the connected head supports. The scales are displayed in the scale index. Please refer to the set scale section for the table correspondence.

Command	Parameters	Answer
DVS	None	The valid scale index



Example

```

Command: *DVS
Answer: [9]: 30.00 n<CR><LF>
        [10]: 100.0 n<CR><LF>
        [11]: 300.0 n<CR><LF>
        [12]: 1.000 u<CR><LF>
        [13]: 3.000 u<CR><LF>
        [14]: 10.00 u<CR><LF>
        [15]: 30.00 u<CR><LF>
        [16]: 100.0 u<CR><LF>
        [17]: 300.0 u<CR><LF>
        [18]: 1.000 m<CR><LF>
        [19]: 3.000 m<CR><LF>
        [20]: 10.00 m<CR><LF>
        [21]: 30.00 m<CR><LF>
        [22]: 100.0 m<CR><LF>
        [23]: 300.0 m<CR><LF>
        [24]: 1.000<CR><LF>
    
```

08 – Get measure mode display

This command returns the PRONTO's measurement mode. Depending on the type of PRONTO, it can be the continuous power mode in W (CWP), the single-shot power mode in W (SSP), or the single-shot energy mode in J (SSE).

Command	Parameters	Answer
GMD	None	CWP = 0 SSP = 3 SSE = 2

The PRONTO-Si only has the CWP mode.



Example

```

Command: *GMD
Answer: Mode: 0<CR><LF>
    
```

09 – Control LCD

This command is used to control the LCD by turning it on and off. The PRONTO is still working even if the LCD is off.

Command	Parameters	Answer
LCD	1: On 0: Off	



Example

Command: *LCD1

Answer:

4.5.2. Data acquisition

10 - Query current value

This command is used to query the value that is currently being displayed by the monitor. The value is displayed in watts or joules.

Command	Parameters	Answer
CVU	None	Data in ASCII (scientific notation)



Examples

For example, a 506.601 watts reading and a -12.25631 milliwatts reading would be displayed like this:

Command: *CVU

Answer: +5.066010e+02<CR><LF>

Command: *CVU

Answer: -1.225631e-02<CR><LF>

11 - Send continuous transmission of data

This command is used to send data to the serial port at a frequency of 6.8 Hz.

Command	Parameters	Answer
CAU	None	Data in ASCII



Examples

For example, with a PRONTO in CWP, a reading of around 500 milliwatts would be displayed like this until the command *CSU is sent:

Command: *CAU

Answer:
+5.066010e-01<CR><LF>
+5.066012e-01<CR><LF>
+5.066014e-01<CR><LF>
+5.066022e-01<CR><LF>
+5.066032e-01<CR><LF>
+5.066042e-01<CR><LF>

...

12 - Stop the CAU command

This command is used to stop the real-time transfer enabled by the CAU command.

Command	Parameters	Answer
CSU	None	

13 – Query new value ready

This command is used to check whether a new value is available from the device. Though optional, its use is recommended when used with a single pulse operation.

Command	Parameters	Answer
NVU	None	New Data Available or New Data Not Available



Example

Command: *NVU

Answer: New Data Not Available <CR><LF>

4.5.3. Setup

14 - Set personal wavelength correction in nm

This command is used to specify the wavelength in nm being used on the detector. The internal memory in the detector contains measured spectral data for a wide range of wavelengths. A valid value is set between the lowest and highest wavelengths supported by the device, and it should not be a floating point value. The input parameter must have five digits. If the desired wavelength does not have five digits, you must enter a zero-padded number. For example, to set the wavelength at 514 nm, you must enter 00514 or 514.0.

Specifying zero as a wavelength or providing an out-of-bound value as a parameter cancels the command.

Command	Parameters	Answer
PWC	Wavelength	

Default: Calibration wavelength (typically 1064 nm, varies with the detector model)



Example

The following example sets the wavelength to 514 nm.

Command: *PWC00514

Answer:

15 - Get wavelength

This command returns the wavelength in nm.

Command	Parameters	Answer
GWL	None	Returns the wavelength in nm



Example

Command: *GWL

Answer: PWC: 1064<CR><LF>

16 - Get attenuator position

This command returns the attenuator position with on or off.

Command	Parameters	Answer
GAT	None	1: On 0: Off



Example

Command: *GAT

Answer: Attenuator: 0<CR><LF>

4.5.4. Control

17 - Set diode zero offset

This command subtracts the current value from all future measurements the moment the command is issued to set a new zero point.

Command	Parameters	Answer
SDZ	None	Please Wait... Done!



Example

Command: *SDZ

Answer: Please Wait... <CR><LF>
Done! <CR><LF>

18 - Clear zero offset

This command undoes the zero offset command to set the zero point at zero (cancel the SDZ command).

Command	Parameters	Answer
COU	None	

19 - Get zero offset

This command returns whether the zero offset has been activated or not.

Command	Parameters	Answer
GZO	None	1: On 0: Off



Example

Command: *GZO

Answer: Zero: 0<CR><LF>

20 - Set user multiplier

This command is used to set the value of the multiplier between 0.5 and 2.5.

Command	Parameters	Answer
MUL	Eight-character numerical value	

Default: 1



Example

The following example sets multiplier = 2.

Command: *MUL00000002
or
*MUL2.000000

Answer:

21 - Get user multiplier

This command returns the multiplier value.

Command	Parameters	Answer
GUM	None	Current multiplier value



Example

Command: *GUM

Answer:
User multiplier: 2.0000000E+00<CR><LF>

22 - Set user offset

This command is used to set the value of the offset.

Command	Parameters	Answer
OFF	Eight-character numerical value	

Default: 0



Example

The following example sets the offset to 1.5 milliwatts.

```
Command: *OFF0.001500      Answer:
         or
         *OFF1.500e-3
```

The other option available is the zero offset. The zero offset operation is done first, before the user multipliers and offsets.

23 - Get user offset

This command returns the offset value.

Command	Parameters	Answer
GUO	None	Current offset value



Example

```
Command: *GUO              Answer:
                             User offset: 1.5000000E-03<CR><LF>
```

4.5.5. Instrument and detector information

24 - Query version

This command is used to query the device to get information about the firmware version and the device type.

Command	Parameters	Answer
VER	None	Version and device type



Example

```
Command: *VER              Answer:  PRONTO version 1.00.08- <CR><LF>
```

25 - Query status

This command is used to query the device to get information about the following characteristics:

- Measure mode
- Maximum, minimum, and current scale
- Maximum, minimum, and current wavelength with and without attenuation
- Attenuator availability and status
- Detector model
- Detector serial number

Command	Parameters	Answer
STS	None	A hexadecimal structure described in the table below

The first byte represents the validity of the structure: 0 represents a valid line while 1 is the end of the structure. The next four bytes represent the address line, and the last four bytes are the actual value. The values are written on 32 bits, which means that all the values are written on two lines. The first line represents the LSB, and the second line represents the MSB.

The following table shows the output with a PRONTO-Si, serial number 199672.

Note that text data values such as detector name and serial number are in ASCII-encoded little-endian 16-bit chunks; byte order must be reversed to be converted into a readable format.

Hexadecimal structure			Converted value	Definition
Valid	Address	Value		
:0	0000	0003	3	Reserved
:0	0001	0000	0	Reserved
:0	0002	0003	3	Reserved
:0	0003	0000	0	Reserved
:0	0004	0000	0	Measure mode LSB
:0	0005	0000	0	Measure mode MSB
:0	0006	0015	21	Current scale LSB (refer to scale index *SCS)
:0	0007	0000	0	Current scale MSB (refer to scale index *SCS)
:0	0008	0019	25	Maximum scale LSB (refer to scale index *SCS)
:0	0009	0000	0	Maximum scale MSB (refer to scale index *SCS)
:0	000A	0011	17	Minimum scale LSB (refer to scale index *SCS)
:0	000B	0000	0	Minimum scale MSB (refer to scale index *SCS)
:0	000C	0428	1064	Current wavelength LSB (nm)
:0	000D	0000	0	Current wavelength MSB (nm)
:0	000E	2968	10600	Maximum wavelength LSB (nm)
:0	000F	0000	0	Maximum wavelength MSB (nm)
:0	0010	00C1	193	Minimum wavelength LSB (nm)
:0	0011	0000	0	Minimum wavelength MSB (nm)
:0	0012	0001	1	Is attenuator available LSB (1= yes 0 = no)
:0	0013	0000	0	Is attenuator available MSB (1= yes 0 = no)
:0	0014	0000	0	Is attenuator on LSB (1= yes 0 = no)
:0	0015	0000	0	Is attenuator on MSB (1= yes 0 = no)
:0	0016	2968	10600	Maximum wavelength with attenuation LSB (nm)
:0	0017	0000	0	Maximum wavelength with attenuation MSB (nm)
:0	0018	00C1	193	Minimum wavelength with attenuation LSB (nm)
:0	0019	0000	0	Minimum wavelength with attenuation MSB (nm)
:0	001A	52 50	R P	Detector name in ASCII (PRONTO-Si)
:0	001B	4E 4F	N O	
:0	001C	4F 54	O T	
:0	001D	53 2D	S -	
:0	001E	00 69	i	00 = Null termination character

Hexadecimal structure			Converted value	Definition
Valid	Address	Value		
:0	001F	CC CC		Bytes reserved for longer detector names. May contain invalid data.
:0	0020	CC CC		
:0	0021	CC CC		
:0	0022	CC CC		
:0	0023	CC CC		
:0	0024	CC CC		
:0	0025	CC CC		
:0	0026	CC CC		
:0	0027	CC CC		
:0	0028	CC CC		
:0	0029	CC CC		
:0	002A	39 31	9 1	Detector serial number, in ASCII (199672)
:0	002B	36 39	6 9	
:0	002C	32 37	2 7	
:0	002D	00 00		00 = Null termination character
:1	0000	00 00		End of structure

26 - Query extended status

This command is used to query the device to get information about the following characteristics:

- Measure mode
- Maximum, minimum, and current scale
- Maximum, minimum, and current wavelength with and without attenuation
- Attenuator availability and status
- Detector model
- Detector serial number
- Autoscale mode
- Zero offset mode
- User multiplier
- User offset

Command	Parameters	Answer
ST2	None	A hexadecimal structure described in the table below

The first byte represents the validity of the structure: 0 represents a valid line while 1 is the end of the structure. The next four bytes represent the address line, and the last four bytes are the actual value. The values are written on 32 bits, which means that all the values are written on two lines. The first line represents the LSB, and the second line represents the MSB.

The following table shows the output with a PRONTO-Si, serial number 199672.

Note that text data values such as detector name and serial number are in ASCII-encoded little-endian 16-bit chunks; byte order must be reversed to be converted into a readable format.

Hexadecimal structure			Converted value	Definition
Valid	Address	Value		
:0	0000	3	3	Reserved
:0	0001	0	0	Reserved
:0	0002	3	3	Reserved
:0	0003	0	0	Reserved
:0	0004	0	0	Measure mode LSB
:0	0005	0	0	Measure mode MSB
:0	0006	11	17	Current scale LSB (refer to scale index *SCS)
:0	7	0	0	Current scale MSB (refer to scale index *SCS)

Hexadecimal structure			Converted value	Definition
Valid	Address	Value		
:0	0008	19	25	Maximum scale LSB (refer to scale index *SCS)
:0	0009	0	0	Maximum scale MSB (refer to scale index *SCS)
:0	000A	11	17	Minimum scale LSB (refer to scale index *SCS)
:0	000B	0	0	Minimum scale MSB (refer to scale index *SCS)
:0	000C	428	1064	Current wavelength LSB (nm)
:0	000D	0	0	Current wavelength MSB (nm)
:0	000E	2968	10600	Maximum wavelength LSB (nm)
:0	000F	0	0	Maximum wavelength MSB (nm)
:0	0010	00C1	193	Minimum wavelength LSB (nm)
:0	0011	0	0	Minimum wavelength MSB (nm)
:0	0012	1	1	Is attenuator available LSB (1= yes 0 = no)
:0	0013	0	0	Is attenuator available MSB (1= yes 0 = no)
:0	0014	0	0	Is attenuator on LSB (1= yes 0 = no)
:0	0015	0	0	Is attenuator on MSB (1= yes 0 = no)
:0	0016	2968	10600	Maximum wavelength with attenuation LSB (nm)
:0	0017	0	0	Maximum wavelength with attenuation MSB (nm)
:0	0018	00C1	193	Minimum wavelength with attenuation LSB (nm)
:0	0019	0	0	Minimum wavelength with attenuation MSB (nm)
:0	001A	52 50	R P	Detector name in ASCII (PRONTO-Si)
:0	001B	4E 4F	N O	
:0	001C	4F 54	O T	
:0	001D	53 2D	S -	
:0	001E	00 69	i	
:0	001F	CC CC		00 = Null termination character
:0	0020	CC CC		
:0	0021	CC CC		
:0	0022	CC CC		
:0	0023	CC CC		
:0	0024	CC CC		
:0	0025	CC CC		
:0	0026	CC CC		
:0	0027	CC CC		
:0	0028	CC CC		
:0	0029	CC CC		
:0	002A	39 31	9 1	
:0	002B	36 39	6 9	
:0	002C	32 37	2 7	
:0	002D	0 0		00 = Null termination character
:0	002E	0000		Reserved
:0	002F	0000		Reserved
:0	0030	0001	1	Is autoscale mode on? LSB
:0	0031	0000	0	Is autoscale mode on? MSB
:0	0032	0000	0	Reserved
:0	0033	0000	0	Reserved
:0	0034	0000	0	Is zero offset on? LSB
:0	0035	0000	0	Is zero offset on? MSB
:0	0036	0000	1.0000	Correction multiplier LSB
:0	0037	3F80	(0x3F800000)	Correction multiplier MSB
:0	0038	0000	0.0000	Correction offset LSB
:0	0039	0000	(0x00000000)	Correction offset MSB
:1	0000	0000	0	End of structure

27 – Return instrument ID

This command is used to get the information about the device type.

Command	Parameters	Answer
IDN	None	Device type



Example

Command: *IDN Answer: PRONTO <CR><LF>

28 – Return instrument firmware version

This command is used to get the firmware version of the device.

Command	Parameters	Answer
GSV	None	Version



Example

Command: *GSV Answer: 1.00.04 <CR><LF>

29 – Return instrument global information

This command is used to get general information about the device. This information is included in the previous commands. The information is the identification number of the firmware, the device model, and the firmware version.

Command	Parameters	Answer
GFW	None	Version and device type



Example

Command: *GFW Answer: 104198, Optical Photodiode 1.00.08-RC3
<CR><LF>

30 – Query battery state

This command is used to get the battery power in percentages.

Command	Parameters	Answer
QSO	None	Number in percentage



Example

Command: *QSO Answer: 98 <CR><LF>

4.6. ERROR MESSAGES

#	Error	Comment
1	Command error. Command not recognized.	Command is invalid.
2	Command error. Command must start with "*"	All text commands must begin with a trig character (*).

5. SAFETY INSTRUCTIONS

5.1. GENERAL

To ensure a long lifetime of accurate measurements, the PRONTO-Si power probe should be maintained within the following ambient conditions:

- Storage environment temperature: 10 °C to 40 °C, RH < 70%
- Operating environment temperature: 15 °C to 28 °C, RH < 70%.

It is possible to store and operate your PRONTO-Si power probe beyond this range. For any specific requirements, please contact your local Gentec-EO representative.

Photodiodes are sensitive to temperature and more specifically for longer wavelengths. It is best to keep the temperature in the range of 22 °C to 25 °C, close to the calibration temperature.

5.2. DAMAGE TO THE OPTICAL ABSORBER MATERIAL

Damage to the optical absorber material is usually caused by exceeding the maximum average incident power density specified by the manufacturer. Refer to the specifications table.

The beam diameter should always be as large as possible to avoid damaging the sensor. **We recommend using a beam size diameter that covers 70% to 80% of the sensor's aperture.** For the PRONTO-Si, this corresponds to a diameter of 7-8 mm.

In any case, the beam's incident area should not be less than 10% of the detector's area. Please contact Gentec-EO to make measurements with smaller beams.

5.3. HOW TO PROPERLY HANDLE THE DEVICE

In addition to the standard safety precautions that should be taken when working with laser radiation, we recommend placing the device on an optical stand when making a measurement. For this use, the device is equipped with 1 mounting hole with an 8-32 thread (see Figure 1. **PRONTO-Si mechanics**

).



Figure 5. Recommended setup when making a measurement

Install the device on an optical stand before placing it in the laser beam path.

Gentec-EO offers a compatible stand for the PRONTO-Si. You can contact your local Gentec-EO representative for the exact model.

It is also possible to place the PRONTO-Si on a horizontal surface and illuminate the sensor from above. The back of the device is flat, so it will stay stable when placed on a horizontal surface.

6. SOURCES OF ERROR

The PRONTO-Si is NIST traceable. Several sources of error may affect your measurements.

6.1. ZERO OFFSET

Zero the offset before any measurement, otherwise all measurements will include a component not related to the laser power. This will add a systematic error to absolute power measurements. This error may disappear from relative power measurements. When you subtract two measurements made under identical conditions, the offset in the second measurement cancels the offset in the first if they are identical. We recommend zeroing the offset for all measurements to eliminate any drift that occurs between measurements.

6.2. OFFSET DRIFT DUE TO TEMPERATURE

The photodiode shunt resistor is sensitive to temperature, which affects the offset value. The sensitivity of the photodiode also has temperature dependence. See Figure 6 for the typical temperature sensitivity dependence over the spectral range of this photodiode.



Tip

When making measurements at very low power levels, allow your system to warm up for 30 minutes or until the offset power is stable for several minutes.

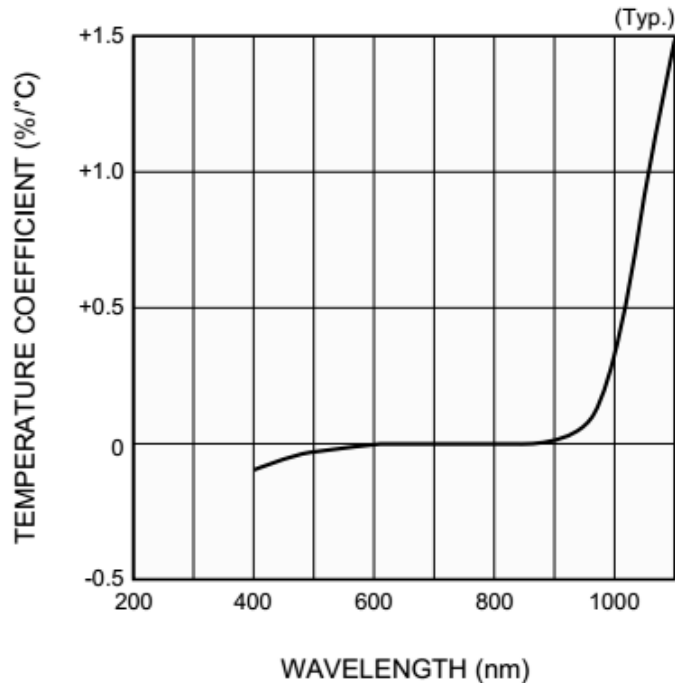

Figure 6. Typical photosensitivity temperature characteristic

The offset drift due to temperature is most important in the near-infrared.

6.3. WAVELENGTH

The photodiode response varies with wavelengths as illustrated in Figure 7.



Warning

Using the wrong wavelength setting will result in incorrect power readings.

For example, a red He-Ne laser generates a 20 mW beam at a wavelength of 633 nm. The photodiode sensitivity at that wavelength is approximately 0.445 A/W, so the PRONTO-Si will receive a signal of 20 mW x 0.445 A/W = 8.9 mA. If the user has set his PRONTO-Si to a wavelength of 800 nm, the instrument assumes a sensitivity of 0.60 A/W, and the measured power is wrong: 8.9 mA / 0.60 A/W = 14.8 mW.

You may select your wavelength with the wavelength menu of the device, as described in Section 3.2.1.

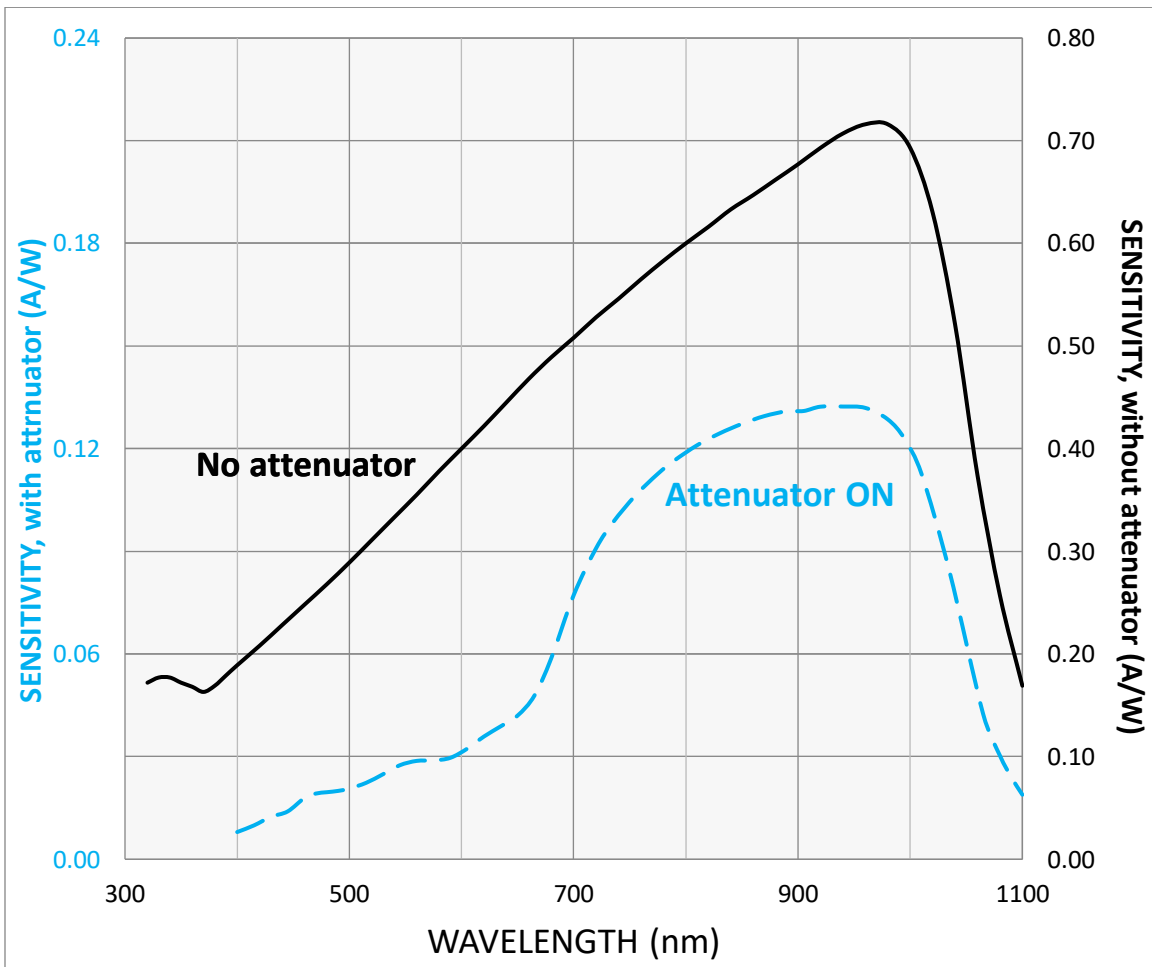

Figure 7. Typical PRONTO-Si sensitivity vs. wavelength²

The photodiode sensitivity is at its highest at 960 nm.

² See

Addendum for older serial numbers.

6.4. MAXIMUM POWER

To obtain precise power readings, the photodiode current is amplified by the PRONTO electronics. However, this amplification saturates at high current values, regardless of the laser power density.



Warning

Measuring a laser beam with power exceeding the maximum values stated here will result in incorrect power readings, even when the damage threshold is not reached.

Since the current generated by the photodiode varies with the wavelength (see Section 0), the maximum power also varies. When you add an attenuator to the photodiode, the photocurrent diminishes, and higher powers can be measured. The attenuation factor is not constant along the light spectrum. Both curves for the maximum power with and without the attenuator are shown below.

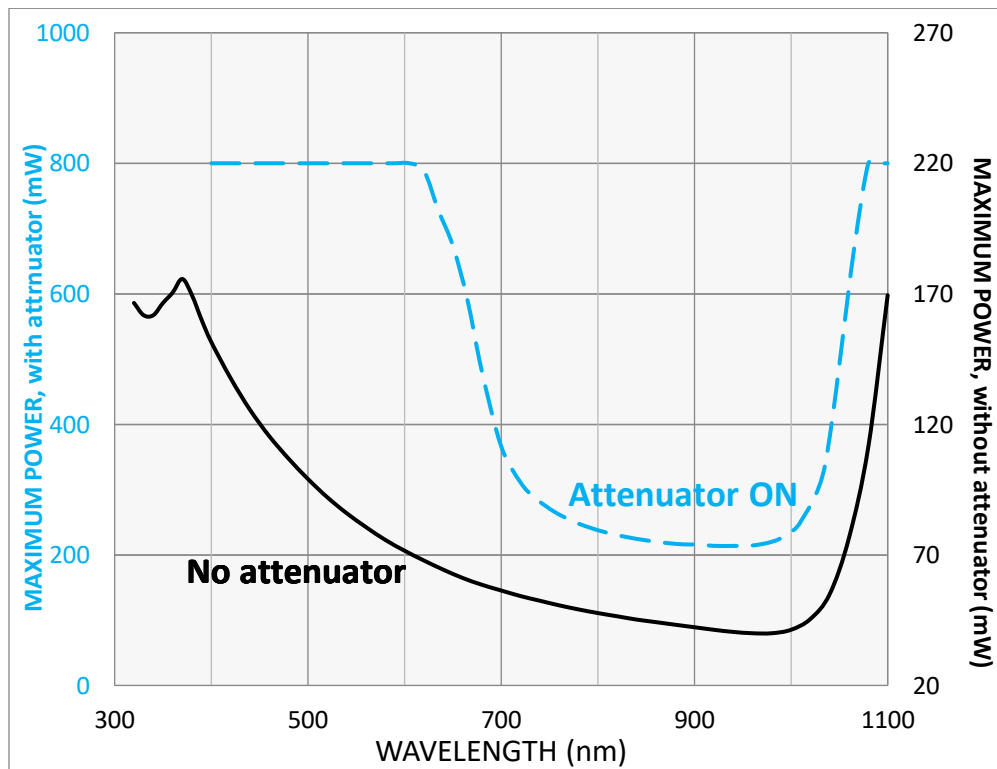

Figure 8. PRONTO-Si maximum power vs. wavelength³

The maximum power is at its lowest when the photodiode sensitivity is at its highest.



Tip

³ See

Addendum for older serial numbers.

When making measurements close to the maximum power without the attenuator, slide on the attenuator to avoid saturated measurements.

7. MAINTENANCE

7.1. FREE FIRMWARE UPGRADE

As new and improved versions of the device's firmware are created, it is in your best interest to update your PRONTO-Si. The latest device firmware can be downloaded from the Gentec-EO website at <https://gentec-eo.com/downloads>. Find the file that corresponds to your PRONTO-Si and follow our simple, easy-to-use instructions.

8. ACCESSORIES

8.1. THREADED ADAPTOR

Gentec-EO offers an SM1 threaded adaptor that can be used with other Gentec-EO SM1-threaded accessories like ND filters for extra attenuation or an FC adaptor for output optical fiber (see Figure 9). Used with the FC fiber adaptor, the distance between the fiber output and the sensor is $3.5 \text{ mm} \pm 0.5 \text{ mm}$. The threaded adaptor is fixed over the sensor with two 4-40 set screws. There is a line drawn on the adaptor to help align the adaptor with the sensor. Once the adaptor is at the desired position, tighten the set screws with a 0.050 hexagonal key.



Figure 9(a). The threaded adaptor for PRONTO-Si (203502) has an SM1 thread

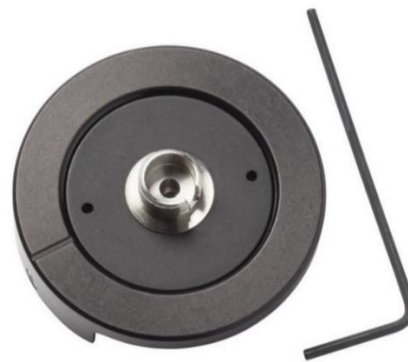

Figure 9(b). Threaded adaptor for PRONTO-Si with an FOA-FULL fiber optics adaptor

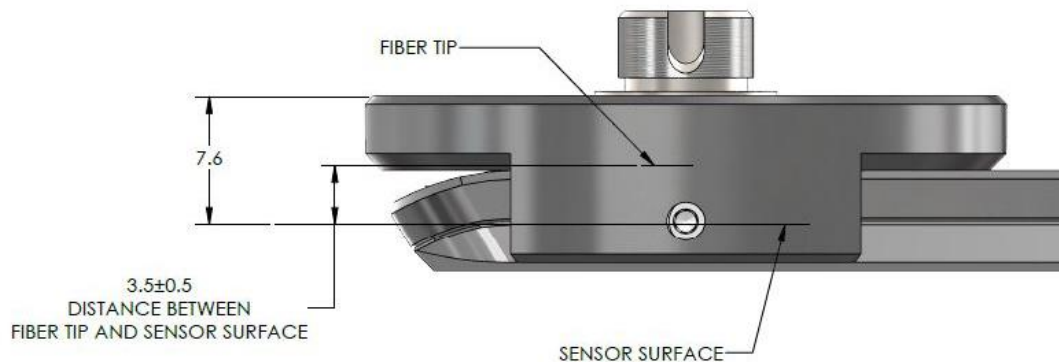

Figure 10. Distance between the sensor surface and optical fiber

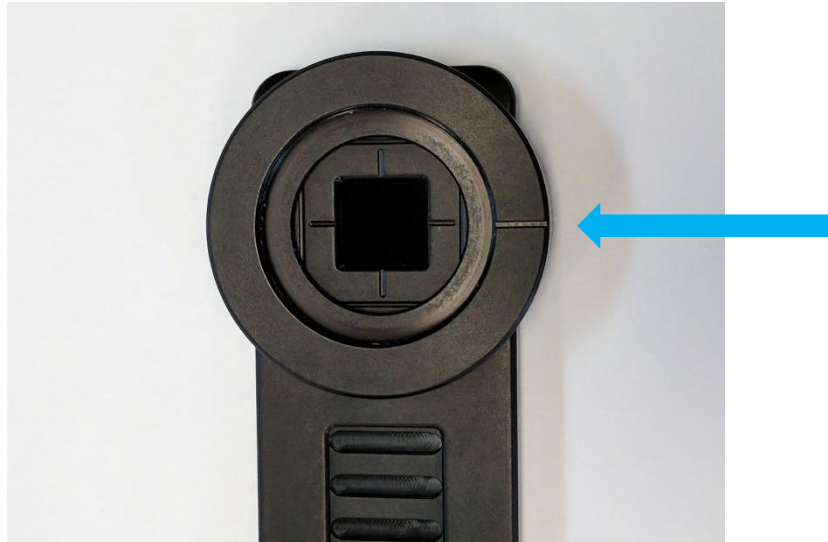

Figure 11. To align the adaptor with the sensor, use the line drawn near the sensor and the one drawn on the adaptor.



Warning

When the threaded adaptor is on the PRONTO-Si, **do not close** it to avoid any damage to the LCD's screen.



Figure 12. Flipping the PRONTO-Si closed when the FC adaptor is attached will damage the touchscreen

**Tip**

For optimal storage, you can put the threaded adaptor on the other side of the PRONTO-Si. This way the touch screen will not be damaged. See Figure 13.



Figure 13. Proper way to store a PRONTO-Si with the threaded adaptor

9. DECLARATION OF CONFORMITY

Application of Council Directive(s): 2014/30/EU The EMC Directive



Manufacturer's name: Gentec Electro Optics, Inc.
 Manufacturer's address: 445, Saint-Jean Baptiste, Suite 160
 Québec (Québec) G2E 5N7
 Canada

European representative name: Laser Components S.A.S.
 Representative's address: 45 bis Route des Gardes
 92190 Meudon (France)

Type of equipment: Optical power monitor
 Model No.: PRONTO series
 Year of test and manufacture: 2015

Standard(s) to which conformity is declared:

Emissions

Product standard	Test standard	Description
EN 61326-1_Ed2:2013 (IEC 61326-1_Ed2:2012)	CISPR 11:+A1:2010 Class A	radiated emissions
EN 61326-1_Ed2:2013 (IEC 61326-1_Ed2:2012)	Radiated emissions FCC part 15 2013) subpart B	Radiated emissions

Immunity

Product standard	Test standard	Description	Performance Criteria
EN 61326-1_Ed2:2013 (IEC 61326-1_Ed2:2012)	IEC61000-4-2:2008Ed.2	Electrostatic Discharge Immunity	Criteria B
EN 61326-1_Ed2:2013 (IEC 61326-1_Ed2:2012)	IEC61000-4-3:2006 +A1:2007+A2:2010	RF conducted Immunity	Criteria A

I, the undersigned, hereby declare that the equipment specified above conforms to the above directive(s) and standard(s).

Place: Québec (Québec)

Date: July 15, 2015

(President)

10. UKCA DECLARATION OF CONFORMITY

Application of Council Directive(s): 2014/30/EU The EMC Directive



Manufacturer's name: Gentec Electro Optics, Inc.
 Manufacturer's address: 445, Saint-Jean Baptiste, Suite 160
 Québec (Québec) G2E 5N7
 Canada

European representative name: Laser Components S.A.S.
 Representative's address: 45 bis Route des Gardes
 92190 Meudon (France)

Type of equipment: Optical power monitor
 Model No.: PRONTO series
 Year of test and manufacture: 2015

Standard(s) to which conformity is declared:

Emissions

Product standard	Test standard	Description
EN 61326-1_Ed2:2013 (IEC 61326-1_Ed2:2012)	CISPR 11:+A1:2010 Class A	Radiated emissions
EN 61326-1_Ed2:2013 (IEC 61326-1_Ed2:2012)	Radiated emissions FCC part 15 2013) subpart B	Radiated emissions

Immunity

Product standard	Test standard	Description	Performance Criteria
EN 61326-1_Ed2:2013 (IEC 61326-1_Ed2:2012)	IEC61000-4-2:2008Ed.2	Electrostatic Discharge Immunity	Criteria B
EN 61326-1_Ed2:2013 (IEC 61326-1_Ed2:2012)	IEC61000-4-3:2006 +A1:2007+A2:2010	RF conducted Immunity	Criteria A

I, the undersigned, hereby declare that the equipment specified above
 conforms to the above directive(s) and standard(s).

Place: Québec (Québec)

Date: December 1, 2021

(President)

11. APPENDIX A: WEEE DIRECTIVE

Recycling and separation procedure for WEEE directive 2012/19/EU

This section is used by the recycling center when the detector reaches the end of its life. Removing the insulation or altering the inside of the monitor will void the detector warranty.

The complete detector contains:

- 1 detector
- 1 cable
- 1 calibration certificate

Separation

Paper: certificate
Printed circuit board: inside the detector
Aluminum: detector casing
Plastic: parts inside the detector
Li-ion cell: battery

12. APPENDIX B: INSTALLING THE PRONTODATATRANSFER SOFTWARE

1. Download and install the driver from our website.
2. Download the software file from our website.
3. Double-click the .exe file to start the installer.

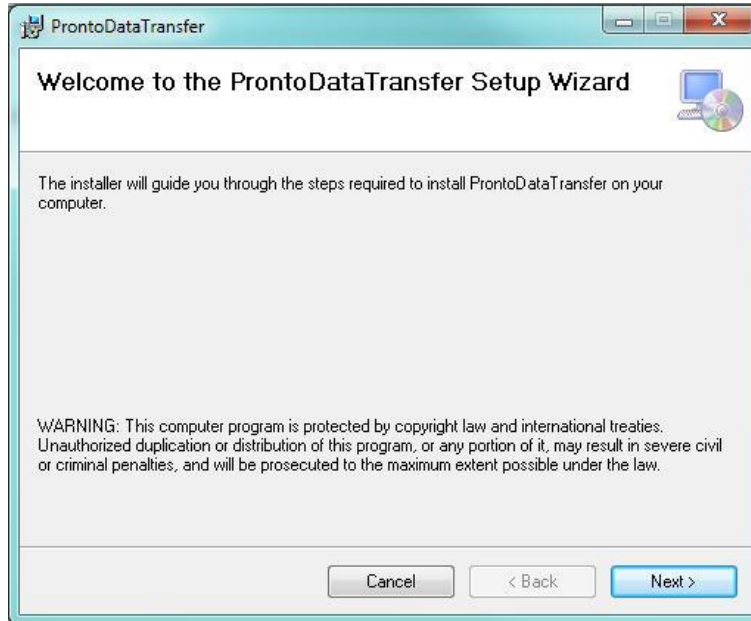

4. Choose the folder for the installation and click next until the installation is complete. Then click close.

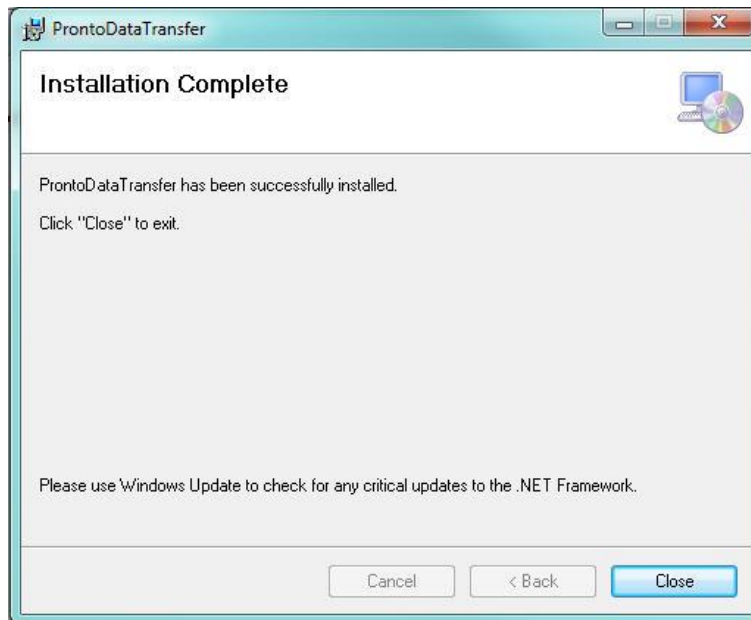

5. Once the software is installed, locate it on your computer and start the program by clicking the ProntoDataTransfer icon.

- A download window appears with a download file button.

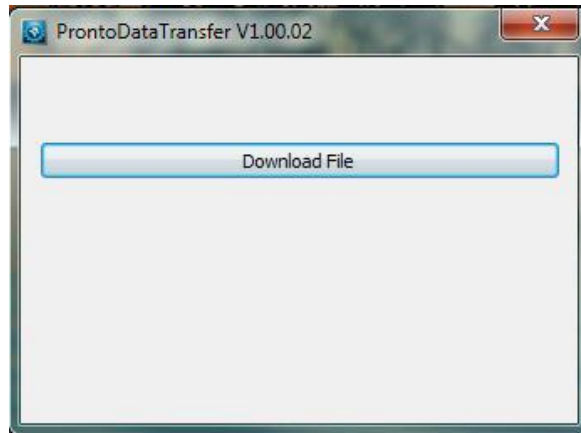

- Click the download file button and select a known folder on your computer where you will save the data. Do not forget to also enter a file name. The file format is .txt.

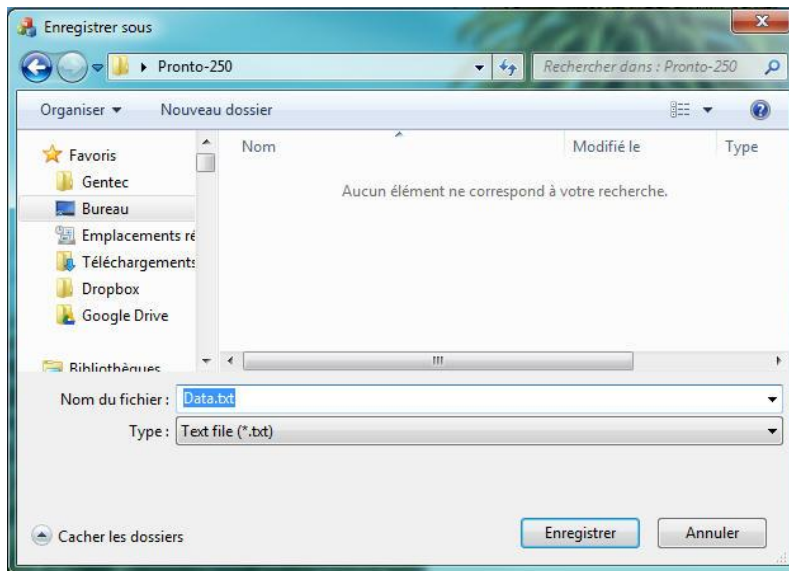

- You can now open and analyze the data in your preferred data analysis software.



13. ADDENDUM

For every PRONTO-Si serial number preceding 293853, the curve below must be considered.

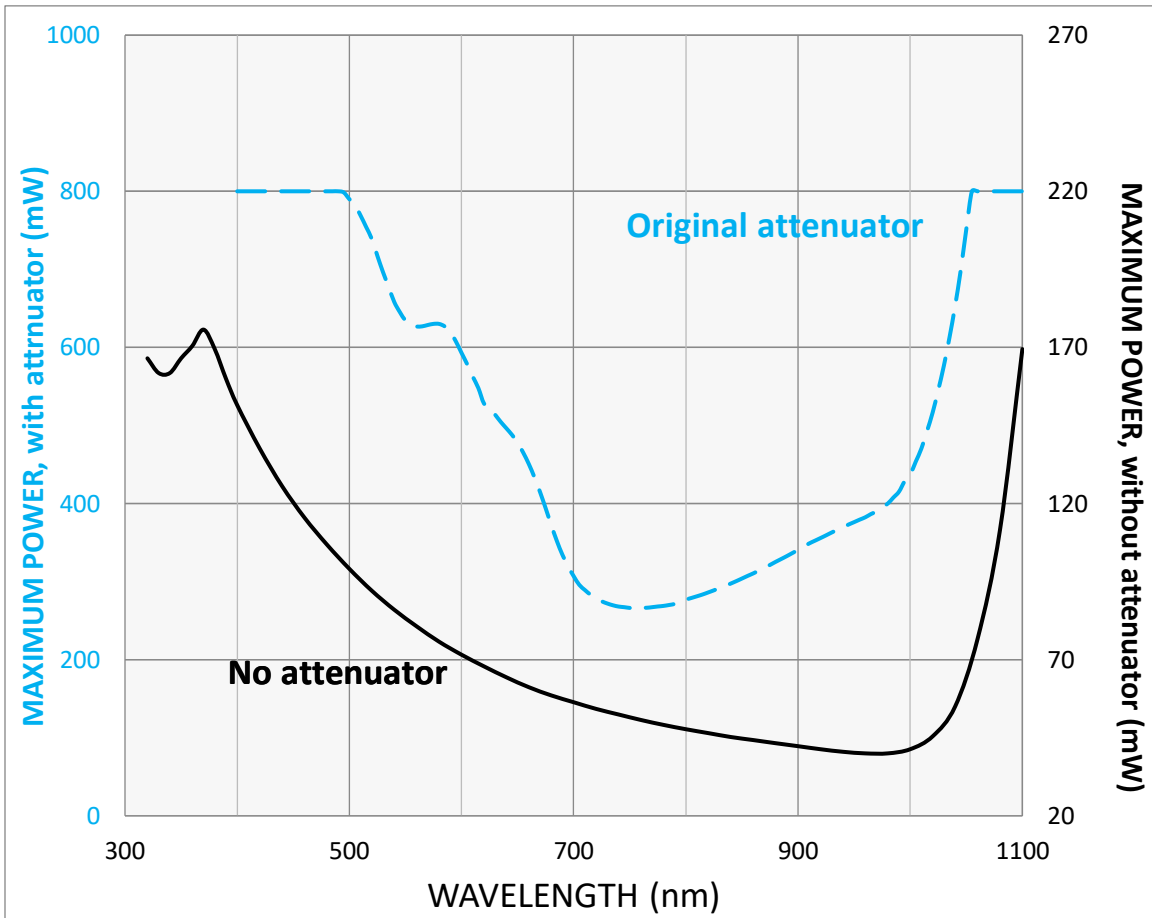

Figure 14. PRONTO-Si maximum power vs. wavelength prior to serial number 293853

The maximum power is at its lowest when the photodiode sensitivity is at its highest.

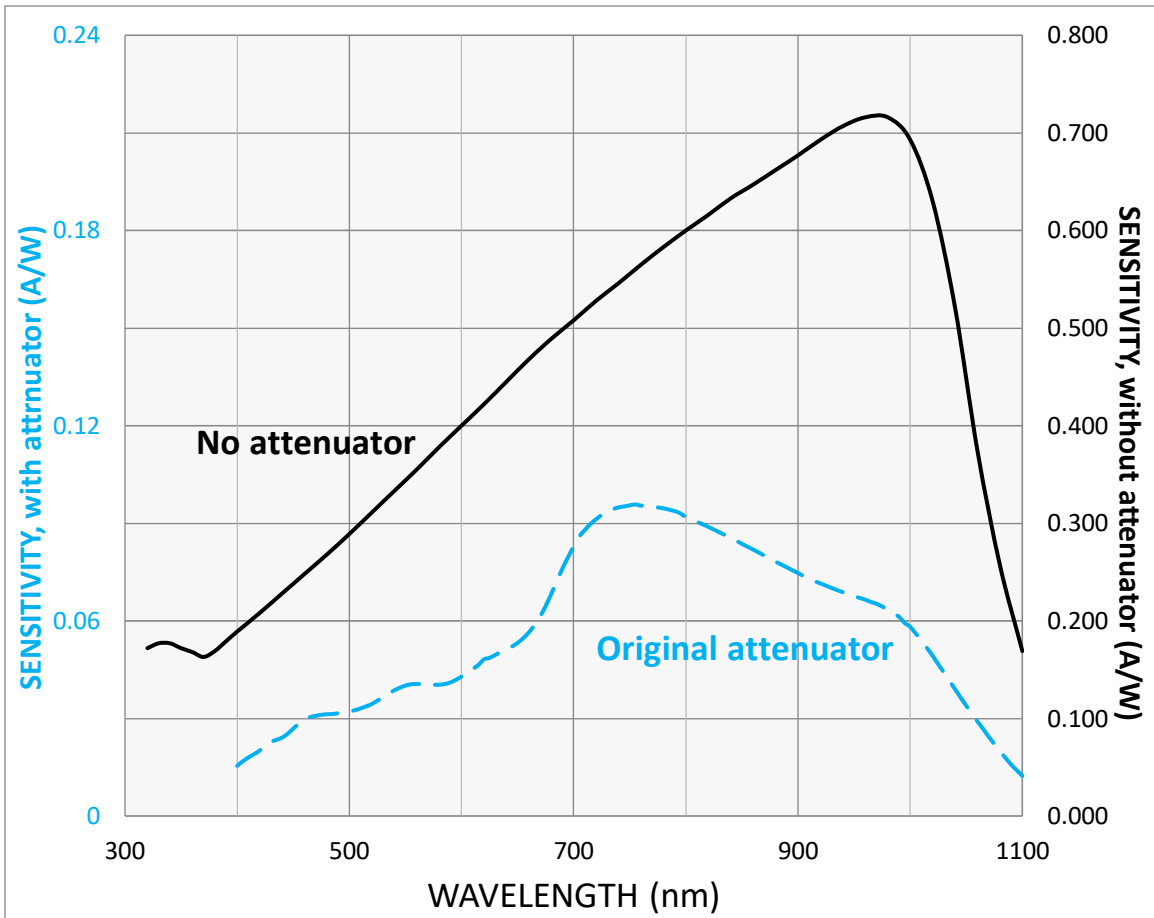

Figure 15. PRONTO-Si maximum power vs. wavelength, prior to serial number 293853

The maximum power is at its lowest when the photodiode sensitivity is at its highest.

LEADER IN LASER BEAM MEASUREMENT SINCE 1972



POWER & ENERGY METERS



BEAM PROFILING



THZ MEASUREMENT

CANADA

445 St-Jean-Baptiste, Suite 160
Quebec, QC, G2E 5N7
CANADA

T (418) 651-8003
F (418) 651-1174

info@gentec-eo.com

UNITED STATES

5825 Jean Road Center
Lake Oswego, OR, 97035
USA

T (503) 697-1870
F (503) 697-0633

info@gentec-eo.com

JAPAN

Office No. 101, EXL111 building,
Takinogawa, Kita-ku, Tokyo
114-0023, JAPAN

T +81-3-5972-1290
F +81-3-5972-1291

info@gentec-eo.com

CALIBRATION CENTERS

- 445 St-Jean-Baptiste, Suite 160
Quebec, QC, G2E 5N7, CANADA
- Werner von Siemens Str. 15
82140 Olching, GERMANY
- Office No. 101, EXL111 building,
Takinogawa, Kita-ku, Tokyo
114-0023, JAPAN