



# USER MANUAL

PH and PE Series | Photo Detectors



## Warranty

### First Year Warranty

The Gentec-EO power and energy detectors carry a one-year warranty (from date of shipment) against material and /or workmanship defects when used under normal operating conditions. The warranty does not cover recalibration or damages related to misuse.

Gentec-EO will repair or replace at its option any wattmeter or joulemeter which proves to be defective during the warranty period, except in the case of product misuse.

Any unauthorized alteration or repair of the product is also not covered by the warranty.

The manufacturer is not liable for consequential damages of any kind.

In the case of a malfunction, contact the local Gentec-EO distributor or nearest Gentec-EO office to obtain a return authorization number. Return the material to the appropriate address below.

### **Contacting Gentec Electro-Optics Inc.**

To help us answer your calls more efficiently please have the model number of the detector you are using ready before calling Customer Support.

#### **All customers:**

Gentec-EO, Inc.  
445 St-Jean-Baptiste, Suite 160  
Quebec, QC, G2E 5N7  
Canada

Tel: (418) 651-8003  
Fax: (418) 651-1174  
Email: [service@gentec-eo.com](mailto:service@gentec-eo.com)  
Web: [www.gentec-eo.com](http://www.gentec-eo.com)

## TABLE OF CONTENTS

<b>WARRANTY .....</b>	<b>2</b>
<b>FIRST YEAR WARRANTY .....</b>	<b>2</b>
<b>TABLE OF CONTENTS.....</b>	<b>3</b>
<b>LIST OF ILLUSTRATIONS.....</b>	<b>4</b>
<b>LIST OF TABLES .....</b>	<b>4</b>
<b>1 PH SERIES PHOTO DETECTORS .....</b>	<b>5</b>
1.1 INTRODUCTION .....	5
1.2 PHOTO DETECTOR CONNECTORS .....	6
1.2.1 DB-15 “intelligent” connector and INTEGRA connector.....	6
1.2.2 Dimensions .....	7
1.3 GENERAL SPECIFICATIONS.....	8
1.4 PH SERIES SPECIFICATIONS.....	8
1.5 PH-B SERIES SPECIFICATIONS.....	11
1.6 PE-B SERIES SPECIFICATIONS .....	12
<b>2 OPERATING INSTRUCTIONS .....</b>	<b>13</b>
2.1 WITH GENTEC-EO MONITORS.....	13
2.2 QUICK POWER MEASUREMENT PROCEDURE.....	13
<b>3 DAMAGE TO THE OPTICAL ABSORBER MATERIAL.....</b>	<b>14</b>
<b>4 ERROR SOURCES.....</b>	<b>14</b>
4.1 OFFSET.....	14
4.2 OFFSET DRIFT DUE TO TEMPERATURE .....	15
4.3 SATURATION.....	16
4.3.1 Procedure with a known transmission value filter .....	16
4.3.2 Attenuator calibration procedure.....	16
4.4 MEASUREMENT OF THE AVERAGE POWER OF A PULSE LASER BEAM .....	16

4.5 WAVELENGTH.....	16
4.5.1 Example.....	17
<b>DECLARATION OF CONFORMITY .....</b>	<b>25</b>
<b>UKCA DECLARATION OF CONFORMITY .....</b>	<b>27</b>
<b>Appendix A: WEEE directive.....</b>	<b>29</b>
1.1 Recycling and separation procedure for WEEE directive 2012/19/EU:.....	29
1.2 Separation:.....	29

### LIST OF ILLUSTRATIONS

FIG. 1-1 PHOTO DETECTOR DIMENSIONS. ....	7
FIG 1-2 TYPICAL GE TEMPERATURE DEPENDENCE VS THE WAVELENGTH.....	15
FIG 1-3 TYPICAL SI AND SIUV TEMPERATURE DEPENDENCE VS THE WAVELENGTH .....	15
FIG. 1-4 PH100-SI, PH100-SI-HA TYPICAL SPECTRAL RESPONSE .....	18
FIG. 1-5 PH100-SI, PH100-SI-HA MAXIMUM POWER .....	18
FIG. 1-6 PH100-SIUV TYPICAL SPECTRAL RESPONSE .....	19
FIG. 1-7 PH100-SIUV MAXIMUM POWER .....	19
FIG. 1-8 PE10B-SI, PH10B-SI SPECTRAL RESPONSE .....	20
FIG. 1-9 PE10B-SI, PH10B-SI MAXIMUM POWER WITH MAESTRO.....	21
FIG. 1-10 PH20-GE, PH5B-GE, PE5B-GE TYPICAL SPECTRAL RESPONSE WITH TEMPETATURE	21
FIG. 1-11 PH20-GE, TYPICAL SPECTRAL RESPONSE .....	22
FIG. 1-12 PH20-GE MAXIMUM POWER .....	22
FIG. 1-13 PE5B-GE, PH5B-GE, TYPICAL SPECTRAL RESPONSE .....	23
FIG. 1-14 PE5B-GE, PH5B-GE, TYPICAL SPECTRAL RESPONSE .....	23
FIG. 1-15 PE3B-IN TYPICAL SPECTRAL RESPONSE.....	24

### LIST OF TABLES

TABLE I. MEASURING RANGES OF GENTEC-EO PH PHOTO DETECTORS.....	5
TABLE II. MEASURING RANGES OF GENTEC-EO PH-B AND PE-B PHOTO DETECTORS .....	5
TABLE III. THE DB-15 CONNECTOR PIN-OUT .....	6
TABLE IV. PH SERIES SPECIFICATIONS FOR GENTEC-EO MONITORS .....	8

## 1 PH SERIES PHOTO DETECTORS

### 1.1 INTRODUCTION

The Gentec-EO Photo Detector family includes nine photo detector sensors..

The PH100-Si, PH100Si-HA detectors use a silicon photodiode.

The PH100-SiUV, PH10B-Si, PE10B-Si, PE3B-Si detectors also use a silicon photodiode but have enhanced sensitivity at shorter wavelengths.

The PH20-Ge, PH5B-Ge, PE5B-Ge detectors use a germanium photodiode.

The PE3B-In detectors use a InGaAs photodiode.

All detector heads are 27.4mm thick by 38.1 mm in diameter.

**Table I. Measuring ranges of Gentec-EO PH photo detectors**

<u>Configuration</u>	<u>PH100-Si series</u>	<u>PH100-SiUV series</u>	<u>PH20 series</u>
Detector alone	0.3 nW to 30 mW	0.3 nW to 4 mW	2 nW to 30 mW
With OD-0.3 attenuator	-	0.6 nW to 8 mW	-
With OD-1 attenuator	3 nW to 300 mW	3 nW to 38 mW	20 nW to 300 mW
With OD-2 Attenuator	30 nW to 750 mW	30 nW to 30 mW	200 nW to 500 mW

Note: quoted maximum ranges are average power at the 1064 nm wavelength for PH100-Si and PH20-Ge, 532 nm for PH100-SiUV, and 850 nm for PH100-SiUV with OD-2

quoted minimum ranges are average power at the 980nm for PH100-Si, 850 nm for PH-100-SiUV and 1550 nm for PH20-Ge (Minimum ranges = 30 X NEP)

**Table II. Measuring ranges of Gentec-EO PH-B and PE-B photo detectors**

PH10B-Si	→	1.5nW to 200μW	PE10B-Si	→	1.5 pJ to 0.075μJ
PH5B-Ge	→	1.2nW to 40μW	PE5B-Ge	→	500 fJ to 2.2nJ
			PE3B-Si	→	8 fJ to 22pJ
			PE3B-In	→	15 fJ to 223pJ

Note PH : quoted minimum and maximum ranges are average power at the 633nm for PH10-Si and 1310nm for PH5B-Ge (Minimum ranges = 30 X NEP). **The M-Link was used for those ranges.**

Note PE : quoted minimum and maximum ranges are average power at the 633nm for PE10/3B-Si and 1310nm for PE3/5B-Ge/In (Minimum ranges = NEE). **The M-Link was used for those ranges.**

The PH and PE series are supplied with a 180 cm long flexible cable terminated with a DB-15 "intelligent" male connector, for use with Gentec-EO Monitors.

NOTE: To eliminate possible damage, do not carry the detector using the connector cable.

The PH and PE photo detectors may also be supplied with a stand.

Call your nearest Gentec-EO distributor to replace the sensor /or to recalibrate the head. See p. ii, **Contacting Gentec Electro-Optics Inc.**

## 1.2 PHOTO DETECTOR CONNECTORS

### 1.2.1 DB-15 “intelligent” connector and INTEGRA connector.

The DB-15 male "intelligent" and INTEGRA connectors contain an EEPROM (Electrical Erasable Programmable Read-Only Memory) that stores information such as the model of the detector, the calibration sensitivity of the available spectral range with or without attenuator and the applicable scales for that specific PH and PE Series head. Wavelengths are not available where the sensor physical properties don't allow it.

The Gentec-EO monitors or PC-GENTEC-EO use the data in those connectors to automatically adjust their characteristics to the power sensor being connected. No calibration procedure is required when installing the power heads, allowing for faster set-up.

**Table III. The DB-15 connector pin-out**

1-	USED BY MONITORS
2-	" " "
3-	" " "
4-	" " "
5-	" " "
6-	+ Output signal
7-	"-" SUPPLY VOLTAGE PH-B/PE-B ONLY
8-	USED BY MONITORS
9-	"+" SUPPLY VOLTAGE PH-B/PE-B ONLY
10-	USED BY MONITORS
11-	" " "
12-	" " "
13-	- Output signal
14-	USED BY MONITORS
15-	" " "
SHELL	- BODY GRND

**NOTE :** Consult Gentec-Eo for supply voltage requirements

### 1.2.2 Dimensions

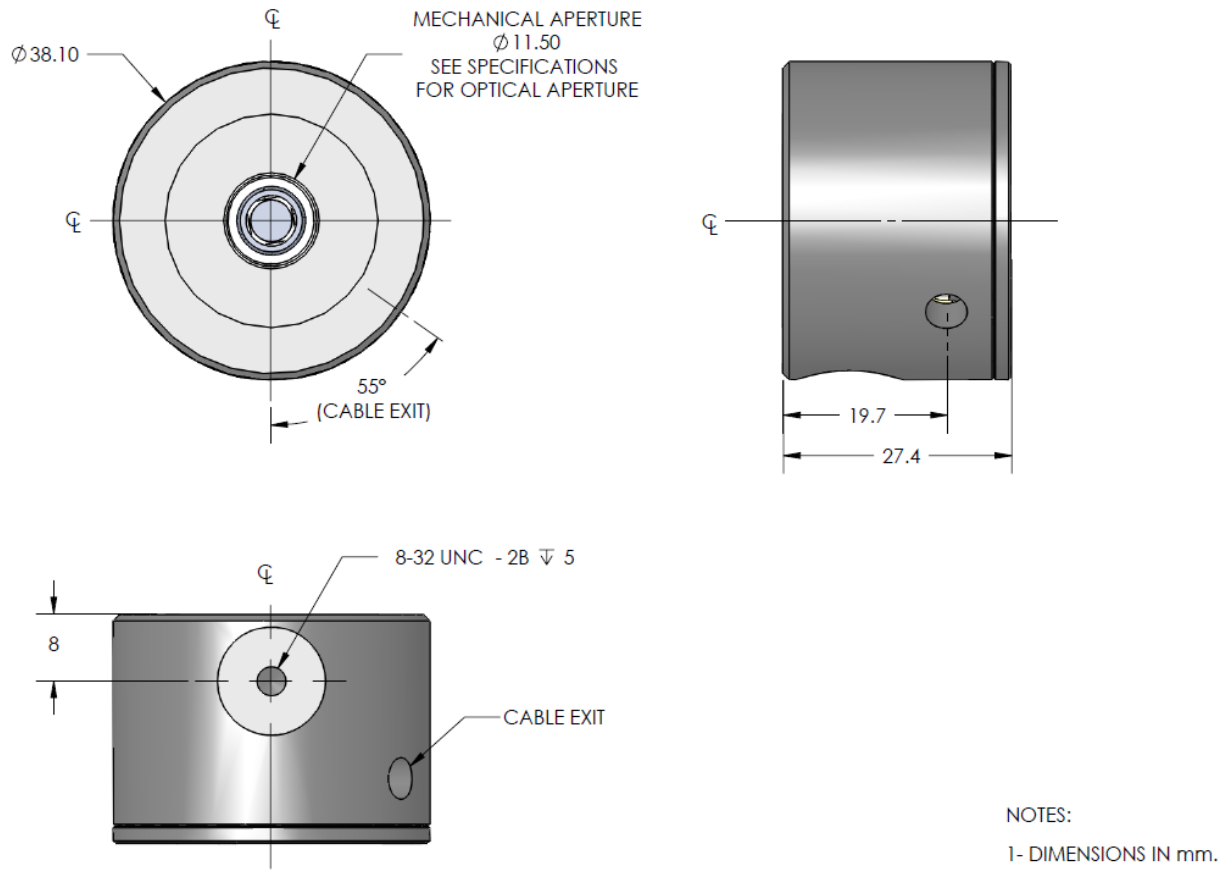

FIG. 1-1 PHOTO DETECTOR DIMENSIONS.

### 1.3 GENERAL SPECIFICATIONS

The following specifications are based on a one-year calibration cycle, an operating temperature of 15 to 28°C and a relative humidity not exceeding 70%. Store between 10 to 50°C and relative humidity not exceeding 70%.

Photodiode are sensitive to temperature and more specifically for longer wavelength. It is the best to keep the temperature in the range of 22°C to 25°C, close to the calibration temperature.

### 1.4 PH SERIES SPECIFICATIONS

Table IV. PH Series Specifications for Gentec-eo Monitors				
Detector	PH100-Si-HA	PH100-Si	PH100-SiUV	PH20-Ge
Monitor Compatibility	Maestro, U-Link, M-Link, P-Link, Uno, Tuner, Solo 2, Solo PE			
Absorber	Silicon	Silicon	Silicon UV	Germanium
Bandwidth	(20 mA to 1 mA) 31 kHz (1 mA to 20 $\mu$ A) 31 kHz (20 $\mu$ A to 2 $\mu$ A) 31 kHz (2 $\mu$ A to 0.1 $\mu$ A) 29 Hz (0.1 $\mu$ A to 1 nA) 16 Hz (Bandwidth Sampling Rate 50kHz, 2048 average values.) Integra : (25 mA to 1 $\mu$ A) 32 kHz ( 1 $\mu$ A to 1 nA) 340 Hz Secondary stage: 3 Hz			
Minimum repetition rate for average power measurements of a pulse laser	(20 mA to 1 mA) 155 kHz (1 mA to 20 $\mu$ A) 155 kHz (20 $\mu$ A to 2 $\mu$ A) 155 kHz (2 $\mu$ A to 0.1 $\mu$ A) 145 Hz (0.1 $\mu$ A to 1 nA) 80 Hz Integra : (25 mA to 1 $\mu$ A) 155 kHz ( 1 $\mu$ A to 1 nA) 1700 Hz			
Spectral range	350 to 1080 nm	320 to 1100 nm	210 to 1080 nm	800 to 1650 nm
Peak sensitivity	980 nm	980 nm	980 nm	1550 nm
Maximum Power typ. [ $\text{@ Power Density}$ ]	36 mW [36 mW/cm <sup>2</sup> ] (@ 1064 nm)	36 mW [36 mW/cm <sup>2</sup> ] (@ 1064 nm)	4 mW [65 mW/cm <sup>2</sup> ] (@ 532 nm)	30 mW [< 320 mW/cm <sup>2</sup> ] (@ 1064 nm)
Minimum Power <sup>a</sup>	0.3 nW @ 980 nm	0.3 nW @ 980 nm	0.3 nW @ 850 nm	2 nW @ 1550 nm

<sup>a</sup> Warm-up until the reading without laser power is stable for several minutes before offset nulling (zeroing the display). Null the offset after each new power up. Half an hour warm-up is recommended for measuring low powers. Temperature  $\pm 0.5$  degrees. display). Null the offset after each new power up. Half an hour warm-up is recommended for measuring low powers. Temperature  $\pm 0.5$  degrees. **Minimum Power = 30 X NEP**



Damage threshold [Maximum Average Power Density]	100 W/cm <sup>2</sup>	100 W/cm <sup>2</sup>	100 W/cm <sup>2</sup>	100 W/cm <sup>2</sup>
Typical Detector saturation current <sup>b</sup>	6.3 mA/cm <sup>2</sup>	6.3 mA/cm <sup>2</sup>	17.6 mA/cm <sup>2</sup>	<140mA/cm <sup>2</sup>
Uncertainty	350-399 nm: ±5.0% 400-449 nm: ±2.0% 450-809 nm: ±1.5% 810-899 nm : ±2.0% 900-1009 nm: ±4.0% 1010-1080 nm: ±7.5%	320-399 nm: ±6.5% 400-899 nm: ±2.5% 900-1009 nm: ±4.0% 1010-1100 nm: ±7.5%	210-229 nm: ±18% 230-254 nm: ±8.0% 255-399 nm: ±6.5% 400-899 nm: ±2.5% 900-1009 nm: ±4.0% 1010-1080 nm: ±7.5%	800-1049 nm: ±5.0% 1050-1559 nm: ±3.5% 1560-1629 nm: ±7.0% 1630-1650 nm: ±10%
Resolution	1.5 pW Integra: 1 fW	1.5 pW Integra: 1 fW	1.5 pW Integra: 1 fW	1.5 pW Integra: 1 fW
Temperature offset dependence, typical	20 pA/°C	20 pA/°C	20 pA/°C	100 pA/°C
Aperture	10 mm diameter	10 mm diameter	10 mm diameter	5 mm diameter
Active Area	0.9 cm <sup>2</sup>	0.9 cm <sup>2</sup>	0.9 cm <sup>2</sup>	0.2 cm <sup>2</sup>
Response time <sup>10-90%</sup>	0.2 sec Integra: 0.45 sec	0.2 sec Integra: 0.45 sec	0.2 sec Integra: 0.45 sec	0.2 sec Integra: 0.45 sec
Beam Position Dependence	±1% @ 780 nm ±3% @ 1064 nm	±1% @ 780 nm ±3% @ 1064 nm	±1% @652 nm ±3% @ 1064 nm	± 1 % @ 1064 nm ±3% @ 800 nm
Noise <sup>c</sup> (peak to peak)	5 pA	5 pA	5 pA	60 pA
Noise equivalent power (NEP)	10 pW @ 980nm	10 pW @ 980nm	10 pW @ 850nm	60 pW @ 1550nm
Dimensions	27.4mm x 38.1mm dia.	27.4mm x 38.1mm dia.	27.4mm x 38.1mm dia.	27.4mm x 38.1mm dia.
Weight	130 g	130 g	130 g	130 g
Sensitivity, typical	0.5 A/W @ 980 nm	0.5 A/W @ 980 nm	0.45 A/W @ 850 nm	0.98 A/W @ 1550 nm

<sup>b</sup> Prior to reaching ±3% linearity error

<sup>c</sup> Lowest scale . Nominal value. Depends on environmental electromagnetic interference. Typical noise on all the Integra scales: 0.06% of Fullscale , maximum noise in the 1uA to 3 uA range: 0.4% of the Fullscale.

With attenuator	PH100-Si - HA OD1/OD2	PH100-Si - OD1/OD2	PH100-SiUV – OD0.3/OD1/OD2	PH20-Ge- OD1/OD2
Maximum Power typ. w/ OD-0.3 <sup>d</sup>	-	-	16 mW @ 300 nm	-
Minimum Power <sup>a</sup> w/ OD-0.3	-	-	0.6 nW @ 850 nm	-
Spectral range w/ OD-0.3	-	-	210 to 1080 nm	-
Maximum Power typ. w/ OD-1	300 mW @ 1064 nm	300 mW @ 1064 nm	38 mW @ 532 nm	300 mW @ 1064 nm
Minimum Power <sup>a</sup> w/ OD-1	6 nW @ 980 nm	6 nW @ 980 nm	6 nW @ 850 nm	20 nW @ 1550 nm
Spectral range w/ OD-1	400 to 1080 nm	400 to 1100 nm	400 to 1080 nm	900 to 1650 nm
Maximum Power typ. w/ OD-2	0.75 W @ 1064 nm	0.75 W @ 1064 nm	30 mW @ 850 nm	0.50 W @ 1064 nm
Minimum Power <sup>a</sup> w/ OD-2	60 nW @ 980 nm	60 nW @ 980 nm	60 nW @ 850nm	200 nW @ 1550 nm
Spectral range w/ OD-2	630 to 1080 nm	630 to 1100 nm	630 to 1080 nm	950 to 1650 nm
Uncertainty w/ OD-0.3, 1 or OD-2 attenuator	400-419 nm: ±5.0% 420-899 nm: ±4.0% 900-1009 nm: ±5.0% 1010-1080 nm: ±7.5%	400-1009 nm: ±5.0% 1010-1100 nm: ±7.5%	210-229 nm: ±18% 230-254 nm: ±8.0% 255-399 nm: ±6.5% 400-1009 nm: ±5.0% 1010-1080 nm: ±7.5%	800-1559 nm: ±5.0% 1560-1629 nm: ±7.0% 1630-1650 nm: ±10%

Specifications subject to change without notice.

<sup>d</sup> Damage Threshold: 0.025 J/cm<sup>2</sup> (355 nm, 10 ns, 10 Hz)

## 1.5 PH-B SERIES SPECIFICATIONS

<b>Table V. PH-B Series Specifications for Gentec-eo Monitors</b>		
Detector	<b>PH10B-Si</b>	<b>PH5B-Ge</b>
Monitor Compatibility	<b>Maestro, U-Link, M-Link, S-Link</b>	
Absorber	Silicon UV	Germanium
Spectral range	210 to 1080 nm	800 to 1650 nm
Peak sensitivity	980nm	1550nm
Sensitivity, typical	15 kV/W @ 633nm	80 kV/W @ 1047 nm
Maximum measurable power	M-Link : 200 $\mu$ W S-Link : 175 $\mu$ W U-LINK / Maestro : 150 $\mu$ W (@ 633nm)	M-Link : 40 $\mu$ W S-Link : 30 $\mu$ W U-LINK / Maestro : 25 $\mu$ W (@ 1310 nm)
Maximum Average Power Density	65 mW/cm <sup>2</sup> (@ 532 nm)	<320 mW/cm <sup>2</sup> (@ 1064 nm)
Noise equivalent power	50 pW (@ 633nm)	40 pW (@ 1310nm)
Minimum Power <sup>e</sup>	1.5 nW (@ 633nm)	1.2 nW (@ 1310nm)
Damage threshold [Maximum Average Power Density]	100 W/cm <sup>2</sup>	100 W/cm <sup>2</sup>
Uncertainty	210-229 nm: $\pm$ 18% 230-254 nm: $\pm$ 8.0% 255-399 nm: $\pm$ 6.5% 400-899 nm: $\pm$ 2.5% 900-1009 nm: $\pm$ 4.0% 1010-1080 nm: $\pm$ 7.5%	800-1049 nm: $\pm$ 5.0% 1050-1559 nm: $\pm$ 3.5% 1560-1629 nm: $\pm$ 7.0% 1630-1650 nm: $\pm$ 10%
Aperture	10 mm diameter	5 mm diameter
Active Area	0.9 cm <sup>2</sup>	0.2 cm <sup>2</sup>
Rise time 0-100%	$\leq$ 0.2 sec	$\leq$ 0.2 sec
Dimensions	38.1mm $\varnothing$ x 27.4 mm	
Weight	91 g	
Beam Position Dependence	$\pm$ 1% @ 652 nm $\pm$ 3% @ 1064 nm	$\pm$ 1% @ 1064 nm $\pm$ 3% @ 800 nm

<sup>e</sup> Warm-up until the reading without laser power is stable for several minutes before offset nulling (zeroing the display). Null the offset after each new power up. Half an hour warm-up is recommended for measuring low powers. Temperature  $\pm$ 0.5 degrees.display). Null the offset after each new power up. Half an hour warm-up is recommended for measuring low powers. Temperature  $\pm$ 0.5 degrees. **Minimum Power = 30 X NEP**

## 1.6 PE-B SERIES SPECIFICATIONS

Table VI. PE-B Series Specifications for Gentec-eo Monitors				
Detector	PE10B-Si	PE5B-Ge	PE3B-Si	PE3B-In
Monitor Compatibility	Maestro, U-Link, M-Link, S-Link			
Absorber	Silicon UV	Germanium	Silicon UV	InGaAs
Spectral range	210 to 1080 nm	800 to 1650 nm	210 to 1080 nm <sup>f</sup>	900 to 1700 nm <sup>f</sup>
Sensitivity, typical	30 MV/J @ 634 nm	1 GV/J @ 1310 nm	100 GV/J @ 634 nm	10 GV/J @ 1310 nm
Rise Time (0-100%)	30 $\mu$ s	25 $\mu$ s	15 $\mu$ s	12 $\mu$ s
Max Repetition Rate	1000 Hz	1000 Hz	1000 Hz	1000 Hz
Max Pulse Width	10 $\mu$ s	10 $\mu$ s	10 $\mu$ s	10 $\mu$ s
Maximum Measurable Energy	U-Link and M-Link : 0.075 $\mu$ J S-Link : 0.081 $\mu$ J Integra : 0.081 $\mu$ J Maestro : 0.069 $\mu$ J (@ 634nm)	U-Link and M-Link : 2.2 nJ S-Link : 2.4 nJ Integra : 2.4 nJ Maestro : 2.0 nJ (@ 1310 nm)	U-Link and M-Link : 22 pJ S-Link : 24 pJ Integra : 24 pJ Maestro : 20 pJ (@ 634 nm)	U-Link and M-Link : 223 pJ S-Link : 245 pJ Integra : 245pJ Maestro : 200 pJ (@ 1310 nm)
Maximum Energy Density	5 $\mu$ J/cm <sup>2</sup>	5 $\mu$ J/cm <sup>2</sup>	n/a	n/a
Max Average Power Density (@ 1064nm)	65 mW/cm <sup>2</sup> (@ 532 nm)	<320 mW/cm <sup>2</sup> (@ 1064 nm)	n/a	n/a
Noise Equivalent Energy <sup>g</sup>	1.5 pJ @ 634nm	1 pJ @ 1310 nm	8 fJ @ 634nm	30 fJ @ 1310nm
Uncertainty	210-229 nm: $\pm$ 18% 230-254 nm: $\pm$ 8.0% 255-399 nm: $\pm$ 6.5% 400-899 nm: $\pm$ 2.5% 900-1009 nm: $\pm$ 4.0% 1010-1080 nm: $\pm$ 7.5%	800-1049 nm: $\pm$ 5.0% 1050-1559 nm: $\pm$ 3.5% 1560-1629 nm: $\pm$ 7.0% 1630-1650 nm: $\pm$ 10%	$\pm$ 4% <b>only</b> @ 634 nm	$\pm$ 4% <b>only</b> @ 1310 nm
Effective Aperture	10 mm $\emptyset$	5 mm $\emptyset$	3 mm $\emptyset$	3 mm $\emptyset$
Active Area	0.9 cm <sup>2</sup>	0.2 cm <sup>2</sup>	0.07 cm <sup>2</sup>	0.07 cm <sup>2</sup>
Dimensions	38.1mm $\emptyset$ x 27.4Dmm			
Weight	91 g			
Beam Position Dependence	$\pm$ 1% @ 652 nm $\pm$ 3% @ 1064 nm	$\pm$ 1% @ 1064 nm $\pm$ 3% @ 800 nm	n/a	n/a

<sup>f</sup> The photodiode is calibrated at one wavelength and spectrally corrected according to a typical curve.

<sup>g</sup> For low energy measurements, the photodiode must be protected from ambient light and ideally used in the dark.

## **2 OPERATING INSTRUCTIONS**

### **2.1 WITH GENTEC-EO MONITORS**

To operate the PH and PE Series photo detector, connect the detector head to the input socket on Gentec-EO monitors with the cable supplied by Gentec-EO before turning the monitor on. (See monitor's instruction manual.)

Adjust the reading to zero before measurements for best accuracy. See procedure in section 2.2 below.

If you are using the fiber optic adapter, put the black protective cover on the detector head before making the offset nulling.

If you want to subtract the room light do the offset nulling with the cover off.

### **2.2 QUICK POWER MEASUREMENT PROCEDURE**

This section will show you the fastest way of making a laser power measurement with Gentec-EO monitors and power detector.

The monitor automatically recognizes all Gentec-EO photo detectors heads of version 5 or higher. Then the monitor automatically downloads all custom technical data for the detector from the EEPROM in the DB-15 connector. This data includes sensitivity, model, serial number, version, wavelength correction factors, and time response.

#### Quick power measurement procedure:

- 1- Install the power head on its optical stand.  
**NOTE:** The PE series must be protected from ambient light, ideally used in the dark to avoid saturation.
- 2- Slide the connector latch to the right to unlock the connector.
- 3- Connect a version 5 (or higher) power detector head using the PROBE INPUT JACK. We recommend turning the monitor off before connecting a new head to avoid losing information from the detector head EEPROM.
- 4- Slide the latch to the left to lock the connector into place.
- 5- Switch the monitor ON or plug the monitor into the computer.
- 6- The monitor will default to autoscale and lowest wavelength without attenuator available. If you have a photodiode detector, you may want to obtain measurements in dBm rather than watts. To do that, select Settings>>Power Unit>>dBm.
- 7- Select the proper wavelength.
- 8- Remove the head's protective cover.

Put the detector head into the laser beam path. The entire laser beam must be within the sensor aperture. Do not exceed maximum specified densities, energies or powers. For the most accurate measurement, spread the beam across 90% of the sensor area.

#### **Adjusting the zero (steps 8 to 10)**

- 9- Block off laser radiation to the detector.
- 10- To reset the zero, wait until the reading has stabilized. The power read by the monitor when no laser beam is incident on the detector may not be exactly zero if the detector or monitor is not thermally stabilized. Warm-up until the reading without laser power is stable for several minutes. Half an hour warm-up is recommended for measuring low powers.
- 11- **Set Diode Zero or Zero Offset or Offset**, (refer to moniator user manual). A message may appears requesting you to put the black cover on your photodiode. Put it on to block all light if you do not want to compensate for background illumination. Do not put it on if you want to remove the signal from ambient light. Press the **ok** after taking the appropriate action with the cover. The monitor passes through all the scales to determine the compensation to null each one. The message "Diode Zero Done" appears when the monitor has finished. You are now ready to make an accurate measurement.
- 12- Apply the laser beam to the detector head.
- 13- The monitor displays the laser beam average power.

### **3 DAMAGE TO THE OPTICAL ABSORBER MATERIAL**

Damage to the optical absorber material is usually caused by exceeding the manufacturer's specified maximum incident in the average power density.

Refer to the specifications pages for the PH Series power head specifications.

Cleaning: Use Alcohol and a clean cotton cloth.

### **4 ERROR SOURCES**

The photodiode and monitor are NIST traceable. Several errors source may affect your measurements.

#### **4.1 OFFSET**

Zero the offset before any measurement as described in Section 2.2 above. Otherwise all measurements will include a component not related to the laser power. This will add a systematic error to absolute power measurements. This error may disappear from relative power measurements. When you subtract two measurements made under identical conditions, the offset in the second measurement cancels the offset in the first if they are identical. We recommend zeroing the offset for all measurements to eliminate any drift that occurs between measurements.

## 4.2 OFFSET DRIFT DUE TO TEMPERATURE

The Photodiode Shunt Resistor is sensitive to temperature, this affects the offset value. When making very low power level measurements, allow your system to warm up for 30 minutes or until the offset power is stable for several minutes. The sensitivity of the photodiode also has temperature dependence. See Fig 1-2 and Fig 1-3 for the typical temperature sensitivity dependence over the spectral range for Ge, Si and SiUV.

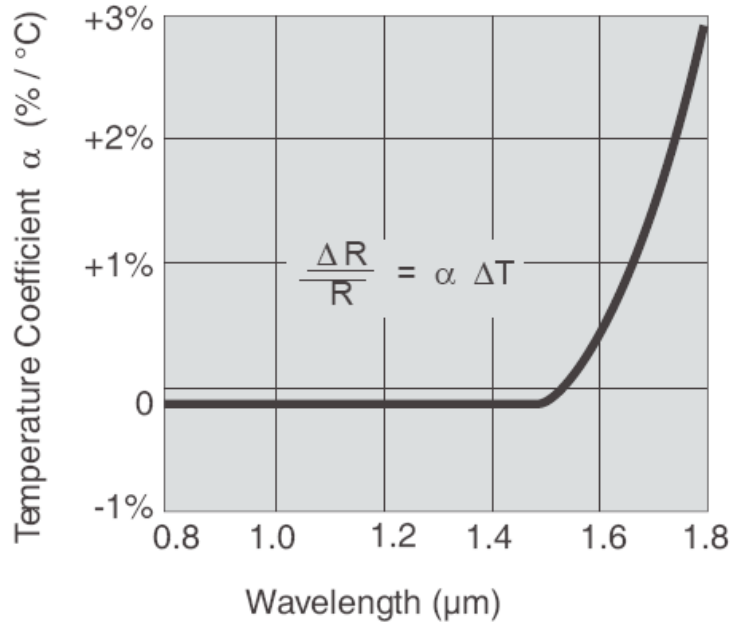

FIG 1-2 TYPICAL GE TEMPERATURE DEPENDENCE VS THE WAVELENGTH

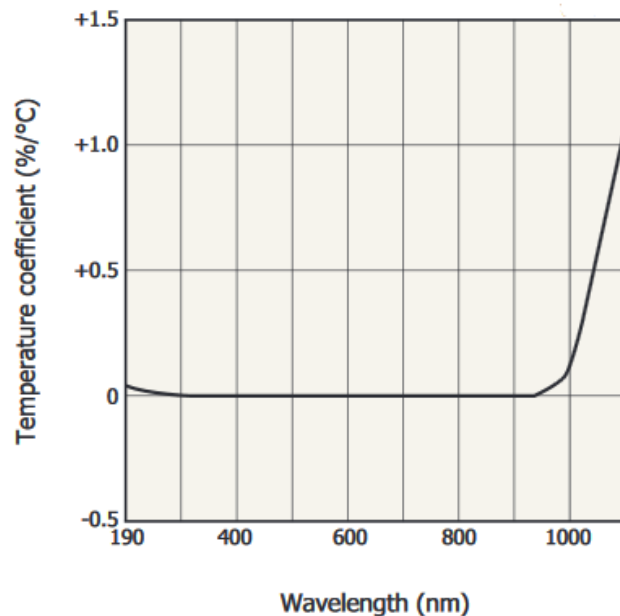

FIG 1-3 TYPICAL SI AND SIUV TEMPERATURE DEPENDENCE VS THE WAVELENGTH

### 4.3 SATURATION

The maximum power varies with wavelength, power density and from one diode to another. When making measurements near the saturation power, you must verify the saturation effect with a calibrated Filter.

#### 4.3.1 Procedure with a known transmission value filter

Make the measurement with and without the filter.  
Your power ratio should be equal to the transmission value of the filter.

#### 4.3.2 Attenuator calibration procedure

Make sure your stable power source is far below the saturation point.  
Make the measurement with and without the filter.  
The transmission value is the ratio of the measurement with filter / without filter.

### 4.4 MEASUREMENT OF THE AVERAGE POWER OF A PULSE LASER BEAM

Conditions to be met:

- The repetition rate must be at least 5 times the analog Bandwidth (see table IV).
- The peak power must not saturate the detector.

To know if the detector is saturated, use procedure 4.3.1. Be careful when making the attenuator calibration in pulse mode. The peak power must be in the linear region of the photodiode.

Peak power = Energy per pulse / pulse width. Energy per pulse = Average power / repetition rate.

### 4.5 WAVELENGTH

The photodiode response varies with wavelength. You may select your wavelength with the *Settings/Wavelength* menu of the monitor or enter you wavelength in the *Settings/Custom* menu of the monitor.

If you decide to use the photo detector without a Gentec-EO monitor, you will have to use the sensitivity given by the photo detector calibration certificate to calculate the power on you laser beam. If your wavelength is not given by the calibration certificate, you will have to make a linear interpolation between two of the available calibration values. Fig. 1-4, Fig. 1-5 and Fig. 1-6 shows the typical spectral response.

Linear interpolation formula:

$$Sensitivity_{desired\_λ} = Sens_{LOW\_λ} + Δλ * Slope$$

$$Δλ = λ_{DESIRED} - λ_{LOW}$$



$$Slope = \frac{(Sens_{HIGH\_λ} - Sens_{LOW\_λ})}{(λ_{HIGH} - λ_{LOW})}$$

Sensitivity<sub>desired\_λ</sub>: The sensitivity at the desired wavelength.

Slope: The slope of the linear interpolation.

Sens<sub>LOW\_λ</sub>: Sensitivity at λ<sub>LOW</sub>.

Sens<sub>HIGH\_λ</sub>: Sensitivity at λ<sub>HIGH</sub>.

λ<sub>LOW</sub>: The next lowest available wavelength near your desired wavelength.

λ<sub>HIGH</sub>: The next highest available wavelength near your desired wavelength.

λ<sub>DESIRED</sub>: Desired Wavelength.

Δλ: The difference between the desired wavelength and the inferior wavelength.

### 4.5.1 Example

You have a PH100-Si and your laser is at 632.8 nm.

See your CERTIFICATE OF CALIBRATION for the sensitivity of your power detector as a function of the wavelength.

Wavelength (nm)	Sensitivity (A/W)
620	0.32
630	0.35
640	0.37
650	0.40
660	0.43

632.8 nm is between 630 nm and 640 nm therefore,

$$Sens_{LOW\_λ} = 0.35 \text{ A/W}$$

$$Sens_{HIGH\_λ} = 0.37 \text{ A/W}$$

$$λ_{LOW} = 630 \text{ nm}$$

$$λ_{HIGH} = 640 \text{ nm}$$

$$Δλ : 632.8 - 630 = 2.8 \text{ nm}$$

$$\text{Slope: } (0.37 - 0.35) / (640 - 630) = 0.002$$

$$\text{Sensitivity}_{desired\_λ} : 0.35 + 2.8 * 0.002 = 0.356 \text{ A/W}$$

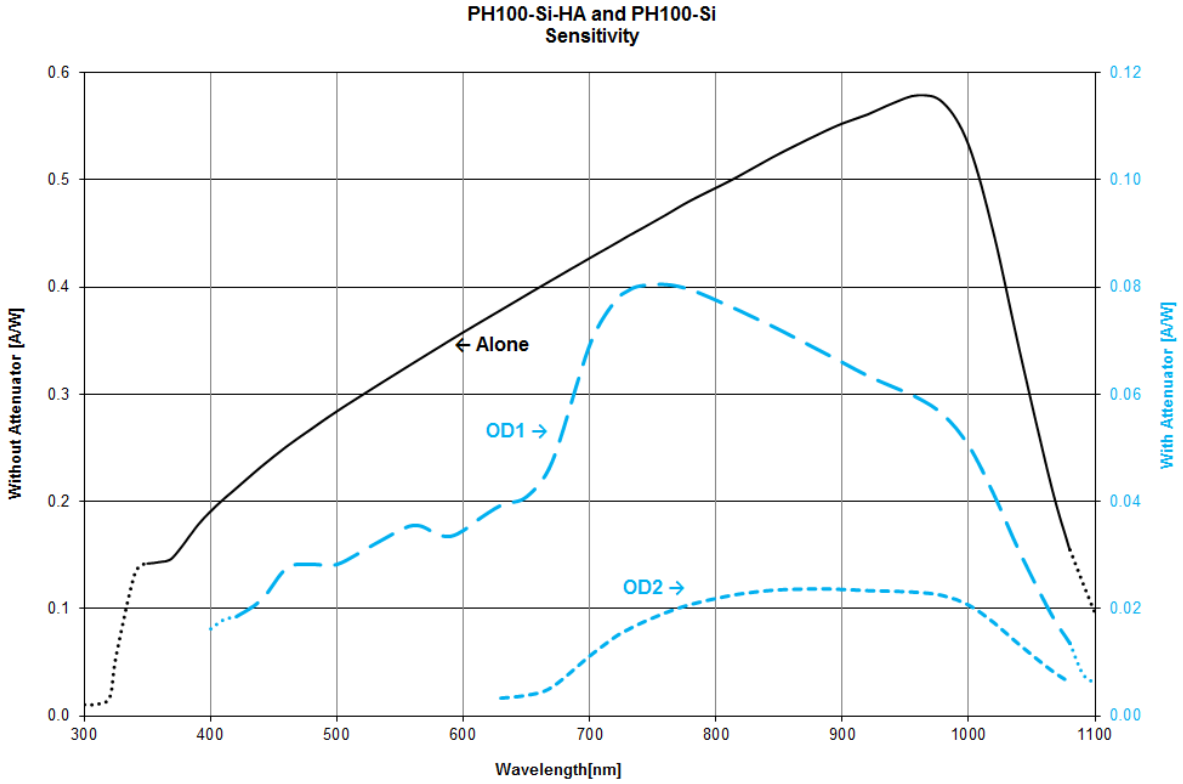

FIG. 1-4 PH100-SI, PH100-SI-HA TYPICAL SPECTRAL RESPONSE

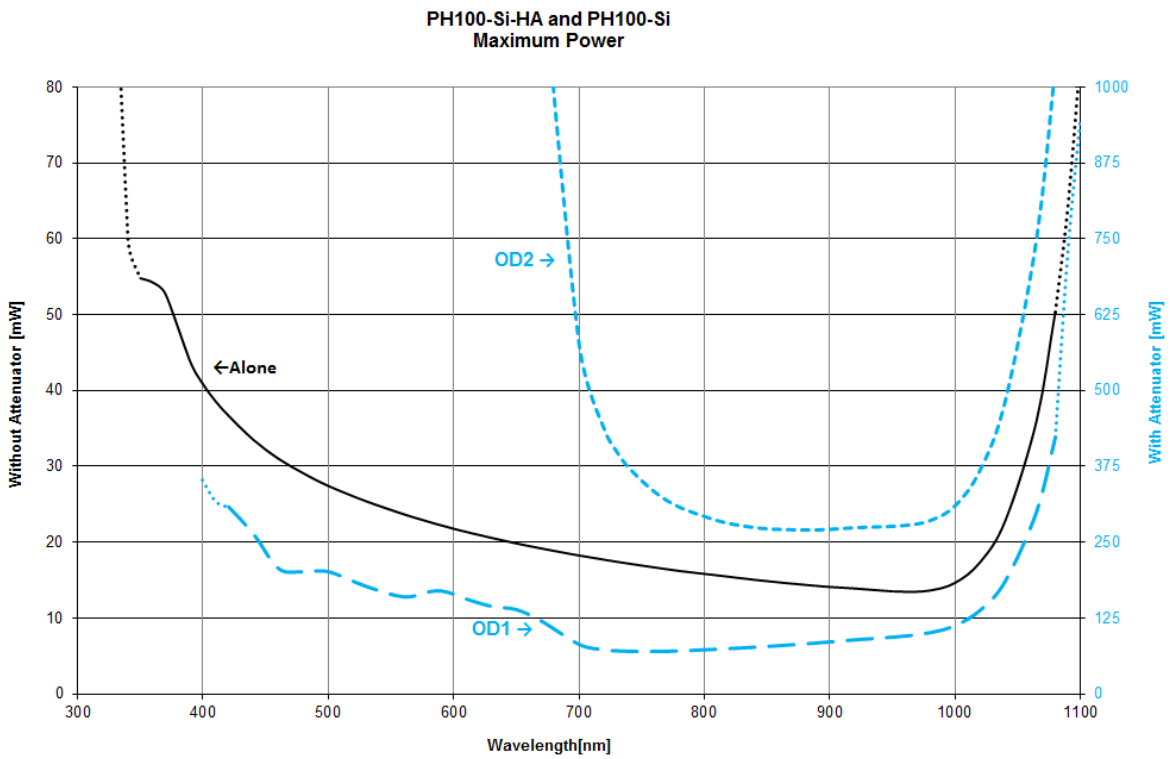

FIG. 1-5 PH100-SI, PH100-SI-HA MAXIMUM POWER

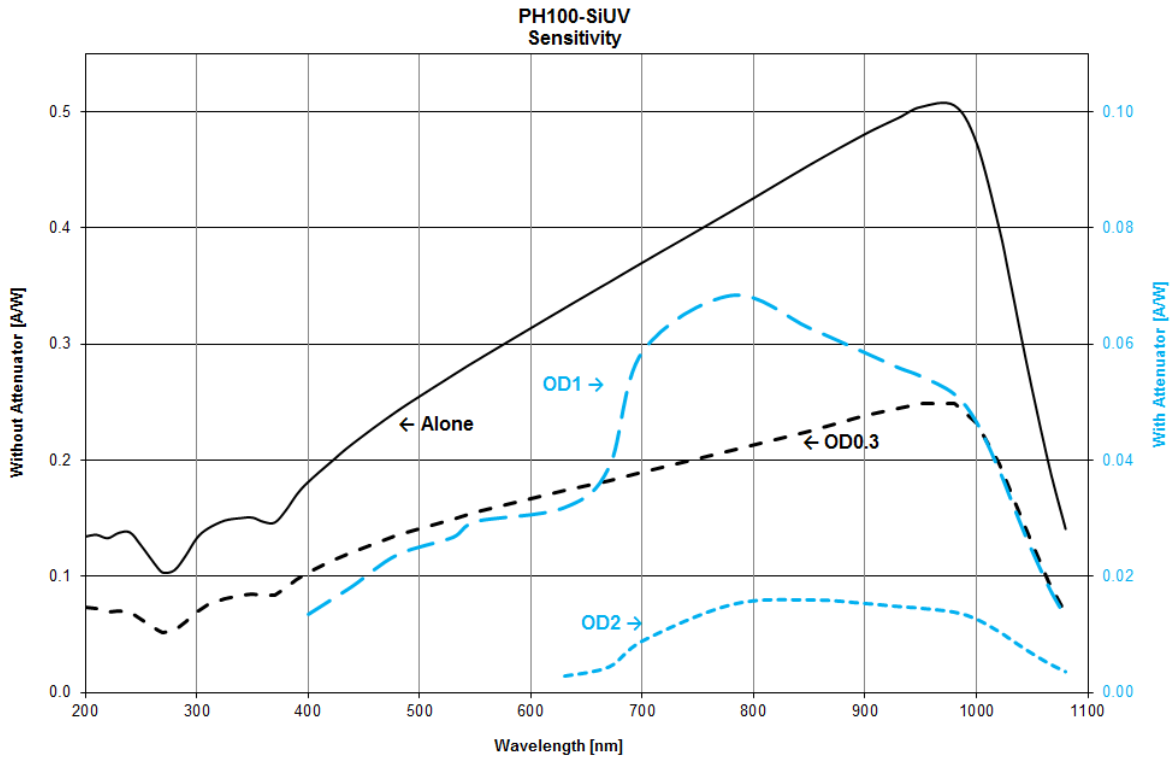

FIG. 1-6 PH100-SiUV TYPICAL SPECTRAL RESPONSE

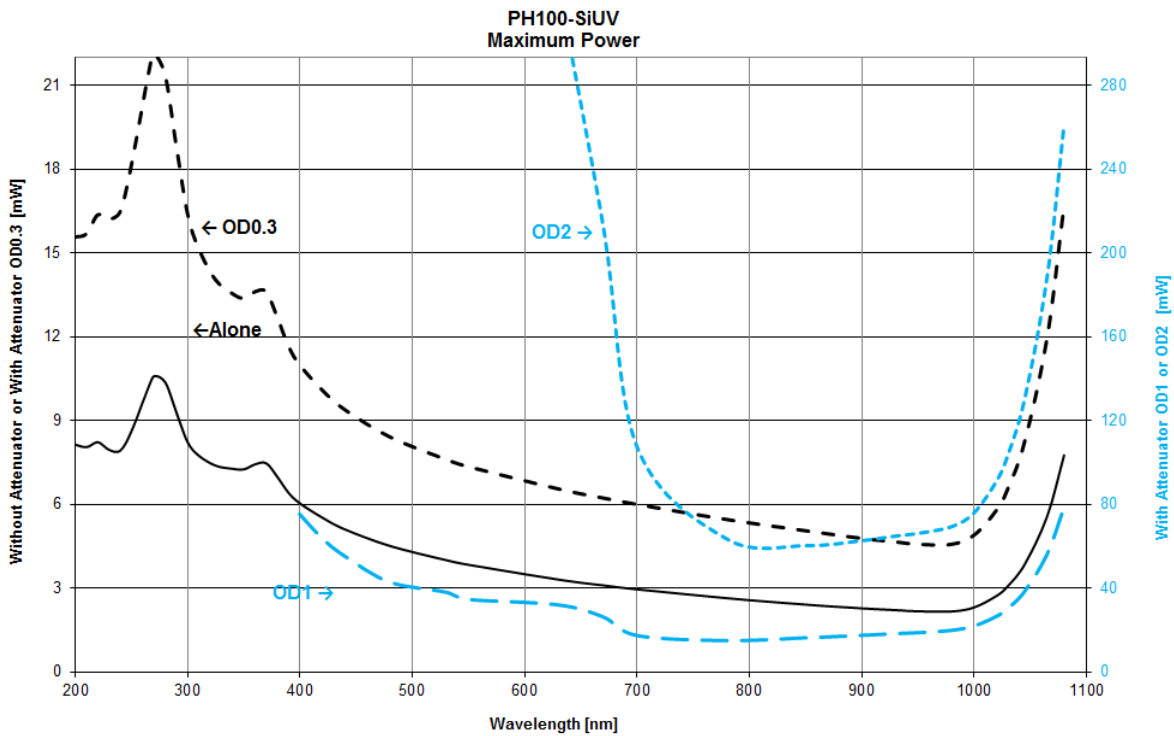

FIG. 1-7 PH100-SiUV MAXIMUM POWER

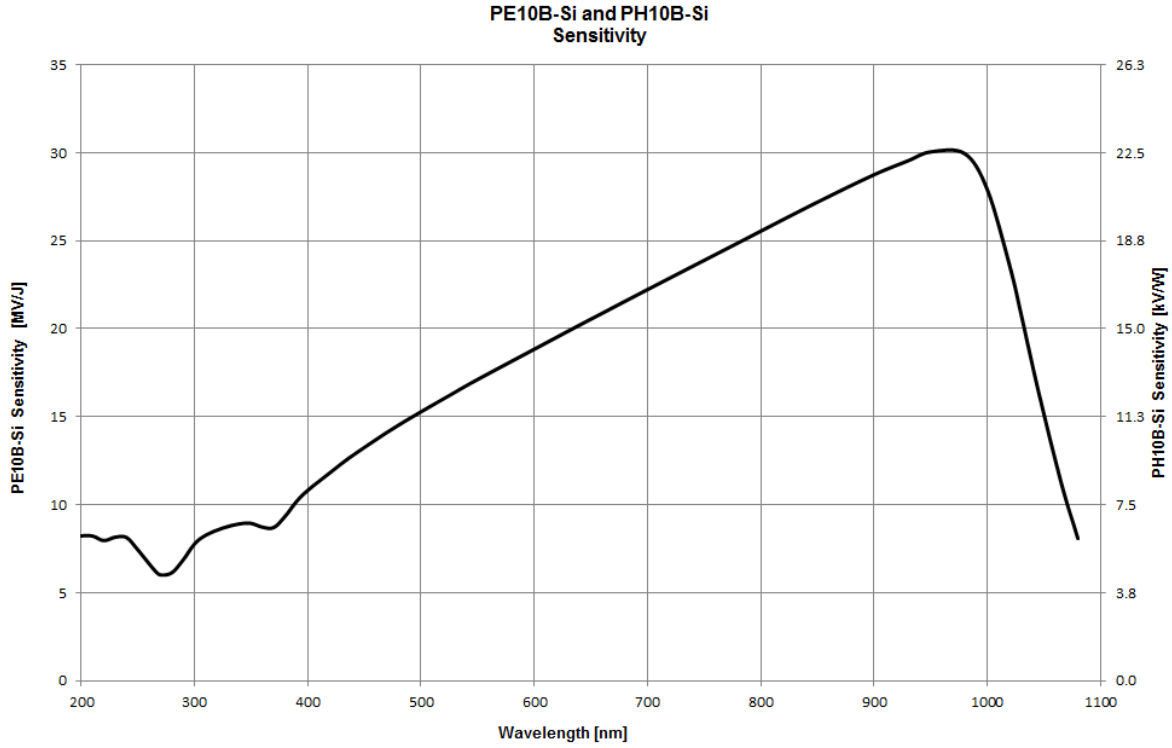

FIG. 1-8 PE10B-SI, PH10B-SI SPECTRAL RESPONSE

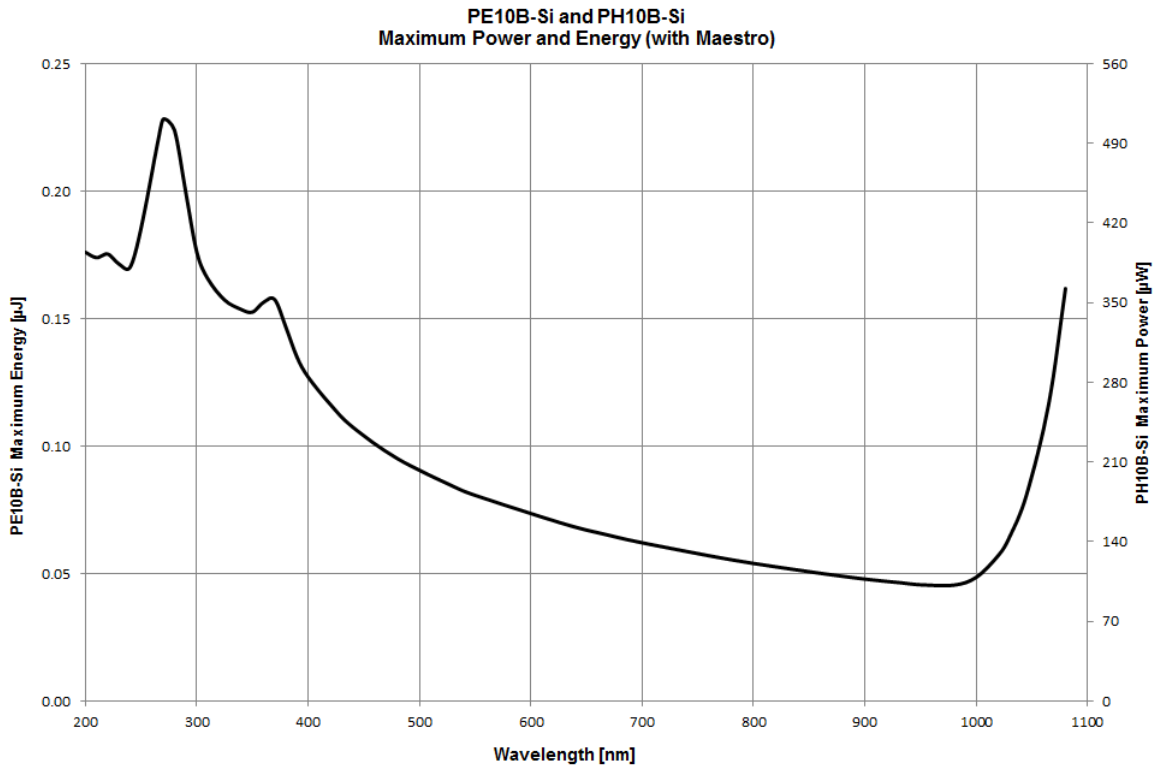

FIG. 1-9 PE10B-SI, PH10B-SI MAXIMUM POWER WITH MAESTRO

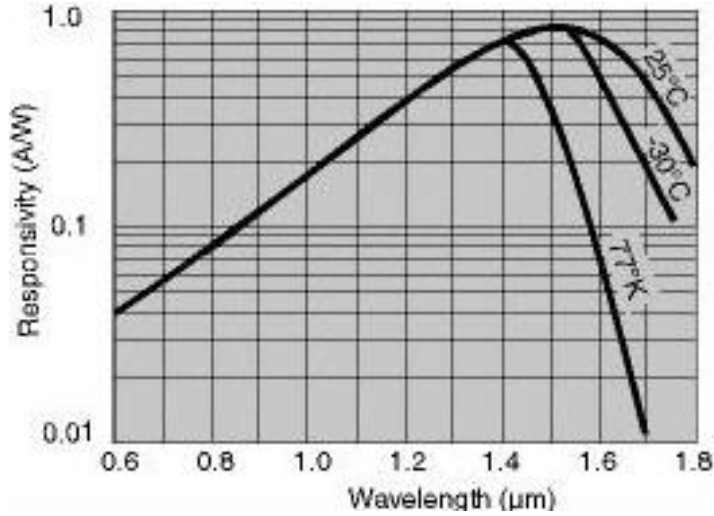

FIG. 1-10 PH20-GE, PH5B-GE, PE5B-GE TYPICAL SPECTRAL RESPONSE WITH TEMPERATURE

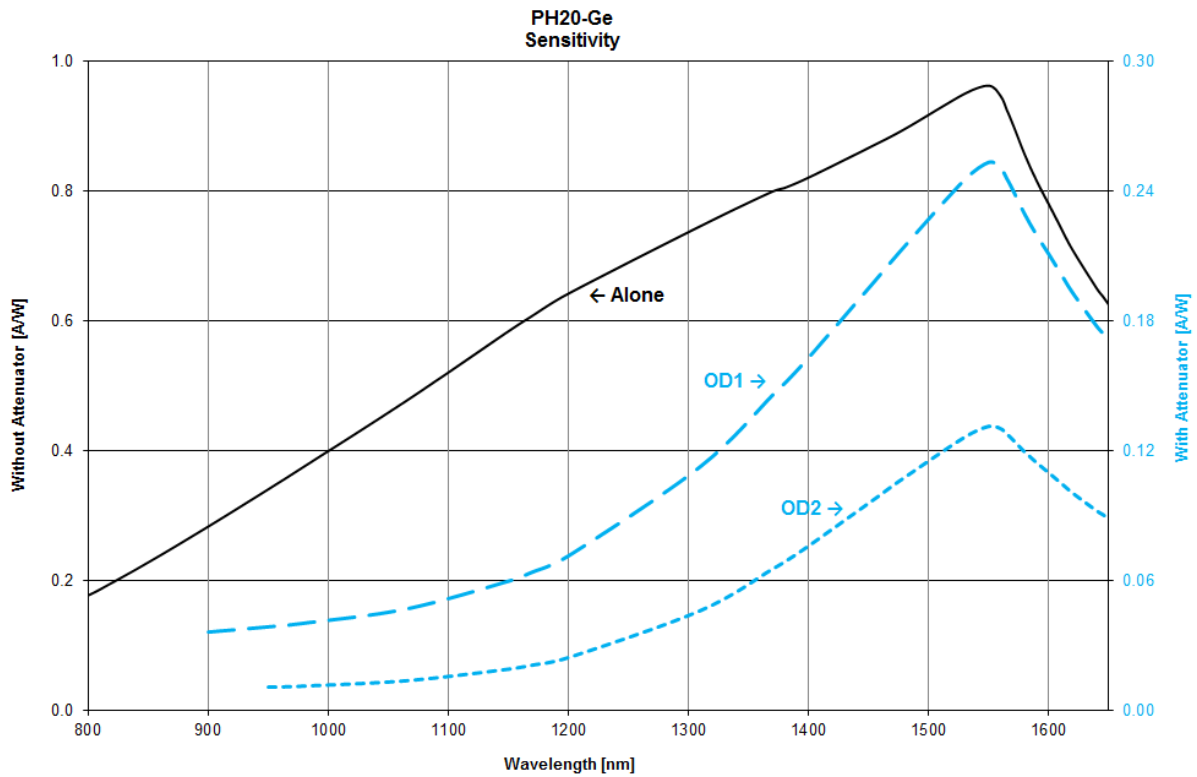

FIG. 1-11 PH20-GE, TYPICAL SPECTRAL RESPONSE

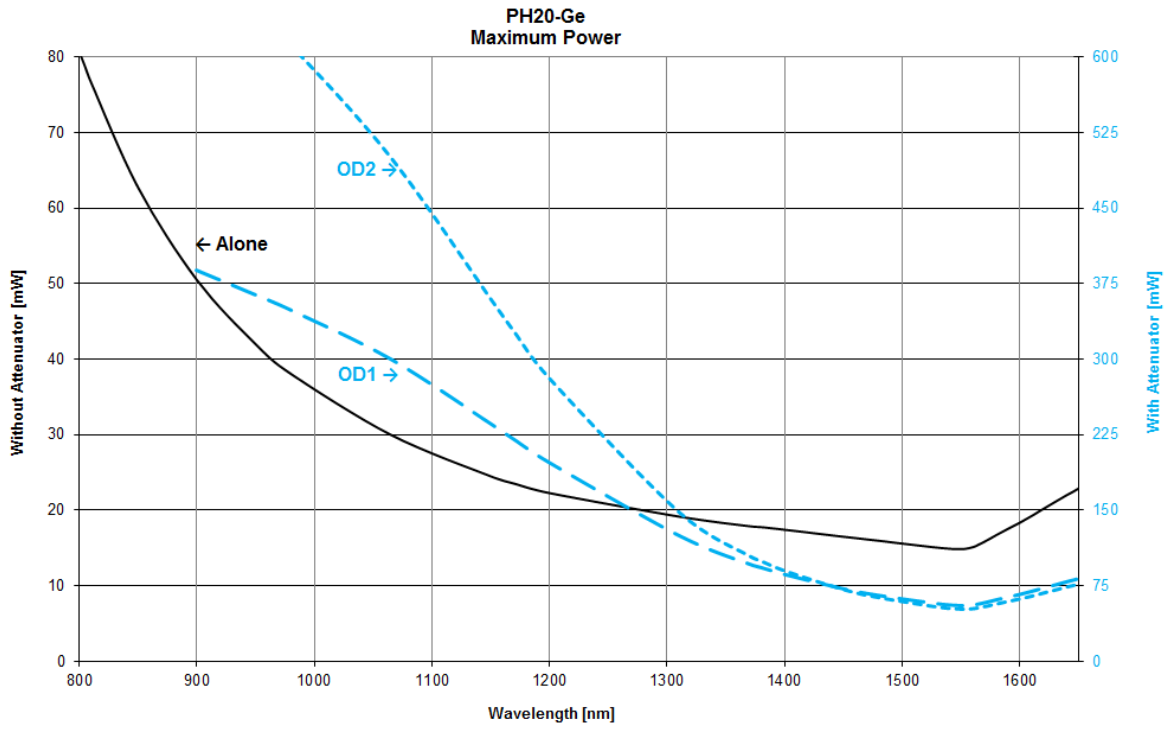

FIG. 1-12 PH20-GE MAXIMUM POWER

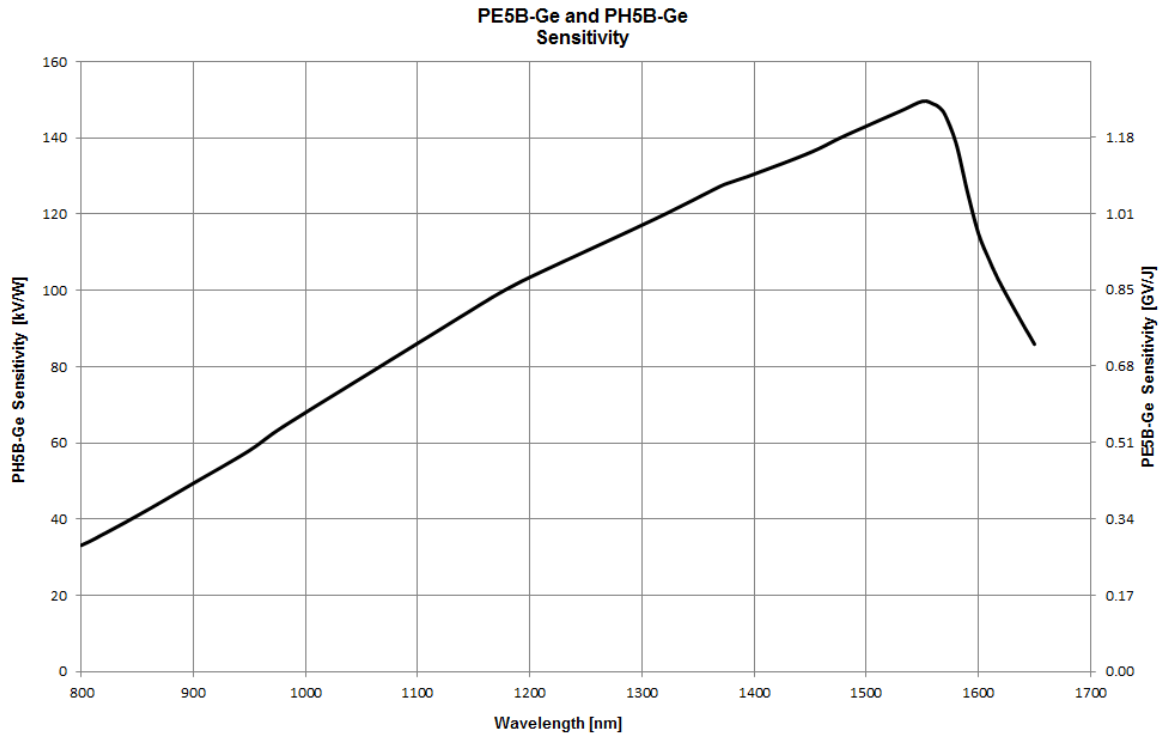

FIG. 1-13 PE5B-GE, PH5B-GE, TYPICAL SPECTRAL RESPONSE

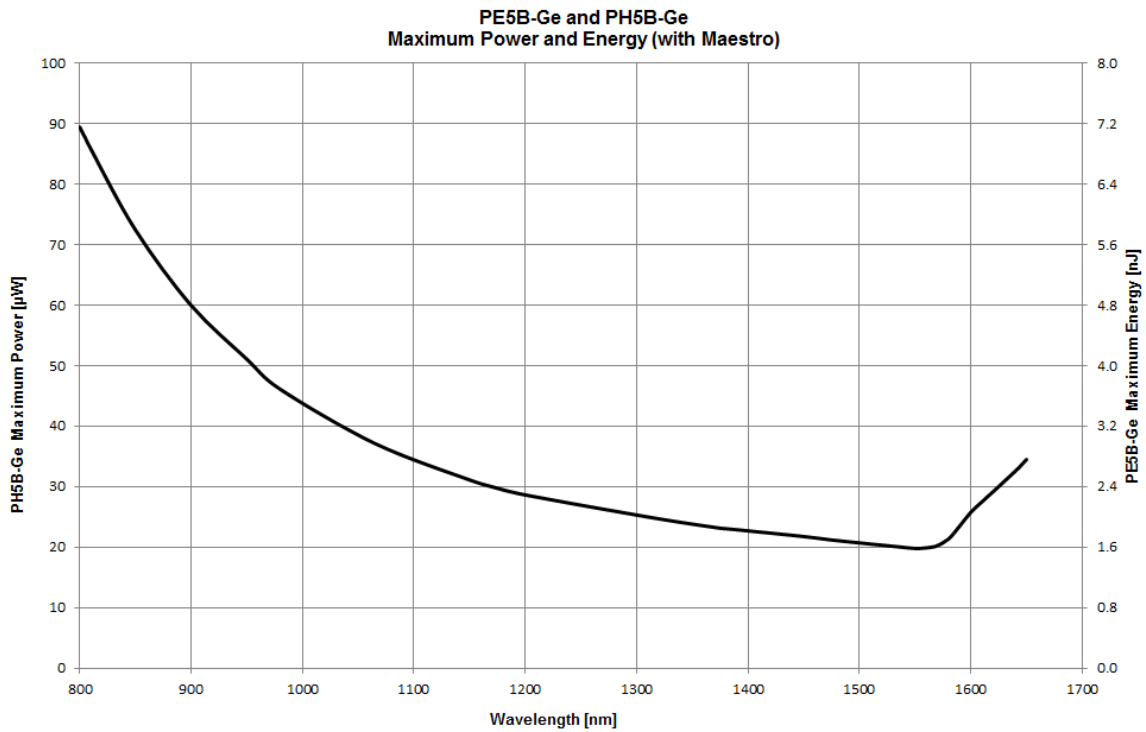

FIG. 1-14 PE5B-GE, PH5B-GE, TYPICAL SPECTRAL RESPONSE

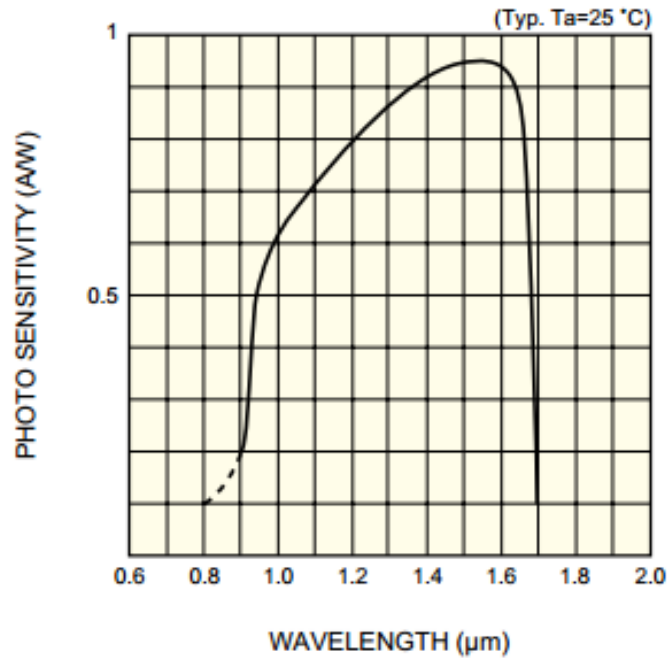

FIG. 1-15 PE3B-IN TYPICAL SPECTRAL RESPONSE



**Declaration of Conformity**

Application of Council Directive(s): 2014/30/EU The EMC Directive



**Manufacturer's Name:** Gentec Electro Optics, Inc.  
**Manufacturer's Address:** 445 St-Jean Baptiste, suite 160  
 (Québec), Canada G2E 5N7

**European Representative Name:** Laser Components S.A.S.  
**Representative's Address:** 45 bis Route des Gardes  
 92190 Meudon (France)

**Type of Equipment:** Photodiode  
**Model No.:** PH Series  
**Year of test & manufacture:** 2016

**Standard(s) to which Conformity is declared:**  
 EN 61326-1: 2006 Emission generic standard

Standard	Description	Performance Criteria
CISPR 11 :2009 A1 :2010	Industrial, scientific and medical equipment – Radio-frequency disturbance characteristics – Limits and methods of measurement	Class A
EN 61000-4-2 2009	Electromagnetic compatibility (EMC) – Part 4-2: Testing and measurement techniques- Electrostatic discharge.	Class B
EN61000-4-3 2006+A2:2010	Electromagnetic compatibility (EMC) – Part 4-3: Testing and measurement techniques- Radiated, Radio Frequency, electromagnetic field immunity test.	Class A
EN61000-4-4 2012	Electromagnetic compatibility (EMC) – Part 4-4: Testing and measurement techniques- Electrical fast transient/burst immunity test.	Class B
EN 61000-4-5 2006	Electromagnetic compatibility (EMC) – Part 4-5: Testing and measurement techniques- Surge immunity test.	Class B

EN 61000-4-6 2013	Electromagnetic compatibility (EMC) – Part 4-6: Testing and measurements techniques- Immunity to conducted Radio Frequency.	Class A
EN 61000-4-11 2004	Electromagnetic compatibility (EMC) – Part 4- 11: Testing and measurement techniques- Voltage dips, short interruptions and voltage variations immunity tests.  Voltage dips: 0% during 1 cycle 40% during 10 cycles	Class B  Class B
EN 61000-3- 2:2006 +A1:2009	Electromagnetic compatibility (EMC) - Part 3-2: Limits - Limits for harmonic current emissions (equipment input current <= 16 A per phase)	Class A

I, the undersigned, hereby declare that the equipment specified above conforms to the above Directive(s) and Standard(s).

Place: Québec (Québec)

Date : Juillet 14, 2016



(President)

**UKCA DECLARATION OF CONFORMITY**

Application of Council Directive(s): 2014/30/EU The EMC Directive



**Manufacturer's Name:** Gentec Electro Optics, Inc.  
**Manufacturer's Address:** 445 St-Jean Baptiste, suite 160  
 (Québec), Canada G2E 5N7

**European Representative Name:** Laser Components S.A.S.  
**Representative's Address:** 45 bis Route des Gardes  
 92190 Meudon (France)

**Type of Equipment:** Photodiode  
**Model No.:** PH Series  
**Year of test & manufacture:** 2016

**Standard(s) to which Conformity is declared:**  
 EN 61326-1: 2006 Emission generic standard

Standard	Description	Performance Criteria
CISPR 11 :2009 A1 :2010	Industrial, scientific and medical equipment – Radio-frequency disturbance characteristics – Limits and methods of measurement	Class A
EN 61000-4-2 2009	Electromagnetic compatibility (EMC) – Part 4-2: Testing and measurement techniques- Electrostatic discharge.	Class B
EN61000-4-3 2006+A2:2010	Electromagnetic compatibility (EMC) – Part 4-3: Testing and measurement techniques- Radiated, Radio Frequency, electromagnetic field immunity test.	Class A
EN61000-4-4 2012	Electromagnetic compatibility (EMC) – Part 4-4: Testing and measurement techniques- Electrical fast transient/burst immunity test.	Class B
EN 61000-4-5 2006	Electromagnetic compatibility (EMC) – Part 4-5: Testing and measurement techniques- Surge immunity test.	Class B

EN 61000-4-6 2013	Electromagnetic compatibility (EMC) – Part 4-6: Testing and measurements techniques- Immunity to conducted Radio Frequency.	Class A
EN 61000-4-11 2004	Electromagnetic compatibility (EMC) – Part 4- 11: Testing and measurement techniques- Voltage dips, short interruptions and voltage variations immunity tests.  Voltage dips:  0% during 1 cycle  40% during 10 cycles	Class B  Class B
EN 61000-3- 2:2006 +A1:2009	Electromagnetic compatibility (EMC) - Part 3-2: Limits - Limits for harmonic current emissions (equipment input current <= 16 A per phase)	Class A

I, the undersigned, hereby declare that the equipment specified above conforms to the above Directive(s) and Standard(s).

Place: Québec (Québec)

Date : November 30, 2021



(President)

## Appendix A: WEEE directive

### 1.1 Recycling and separation procedure for WEEE directive 2012/19/EU:

This section is used by the recycling center when the detector reaches its end of life. Breaking the calibration seal or opening the monitor will void the detector warranty.

The complete Detector contains

- 1 Detector with wires or DB-15.
- 1 instruction manual
- 1 calibration certificate
- 1 Electronic PCB (Integra option)
- 1 Plastic enclosure (Integra option)

### 1.2 Separation:

Paper : Manual and certificate

Wires: Cable Detector.

Printed circuit board: inside the Detector or DB-15, no need to separate (less than 10 cm<sup>2</sup>).

Aluminum: Detector casing. Inside the integra enclosure, no need to separate (less than 10 cm<sup>2</sup>).

Aluminum: Detector casing.

Plastic: Integra enclosure.

# LEADER IN LASER BEAM MEASUREMENT SINCE 1972



POWER & ENERGY METERS



BEAM PROFILING



THZ MEASUREMENT

## CANADA

445 St-Jean-Baptiste, Suite 160  
Quebec, QC, G2E 5N7  
CANADA

T (418) 651-8003  
F (418) 651-1174

[info@gentec-eo.com](mailto:info@gentec-eo.com)

## UNITED STATES

5825 Jean Road Center  
Lake Oswego, OR, 97035  
USA

T (503) 697-1870  
F (503) 697-0633

[info@gentec-eo.com](mailto:info@gentec-eo.com)

## JAPAN

Office No. 101, EXL111 building,  
Takinogawa, Kita-ku, Tokyo  
114-0023, JAPAN

T +81-3-5972-1290  
F +81-3-5972-1291

[info@gentec-eo.com](mailto:info@gentec-eo.com)

## CALIBRATION CENTERS

- 445 St-Jean-Baptiste, Suite 160  
Quebec, QC, G2E 5N7, CANADA
- Werner von Siemens Str. 15  
82140 Olching, GERMANY
- Office No. 101, EXL111 building,  
Takinogawa, Kita-ku, Tokyo  
114-0023, JAPAN